



FS-GT2B

用户手册

INSTRUCTION MANUAL



AFHDS
AUTOMATIC FREQUENCY
HOPPING DIGITAL SYSTEM

Digital proportional radio control system

Http://www.flysky-cn.com
Copy right 2008@flysky co., ltd





MODELS : FS-GT2B

Digital proportional radio control system

menu

1.Introduction.....	2
2.Services.....	2
3.The special symbols.....	3
4.Safty guides.....	3
5. 2. 4GHz system.....	4
6.Battery charging notes.....	5
7. Transmitter parameters.....	6
8.Receiver parameters.....	6
9.Receiver connectivity.....	7
10. 2. 4G Operation notes.....	9
11.Each part of the transmitter.....	11
12.Transmitter function notes.....	12
13. Failsafe function.....	13
14.Simulate.....	15
16.Packaging with content list.....	17





MODELS : FS-GT2B

Digital proportional radio control system

1. INTRODUCTION

Thank you for choosing 2.4 G ratio remote control digital products, if you are the first time to use this type of products, please read this statement carefully and strictly in accordance with the requirements of operation. You could refer to the manual if you meet any problems during the operation. Please well keep the manual after use because you might have to use it again next time. Once again, thanks for buying our products.

FLYSKY

非常感谢您选择使用  2.4G数码比率遥控产品，如果你是第一次使用该类产品，请您在使用之前先仔细阅读此说明书，并严格按说明要求进行操作。在操作过程中您如果遇到同样可以查看说明书。说明书在使用完后请您妥善保管好，以备后用。再次感谢您使用  的产品，并希望它能给您带来快乐。

FLYSKY

2. SERVICES

If you find any problems during the operation process, please refer to the manual. If the problem still exist, you could contact our dealers to find out the way to solve. And you could also log on to our website service center:

[HTTP:WWW.FLYSKY-CN.COM](http://www.flysky-cn.com)

如果您在使用过程中发现有问題,请您第一时间先查看数控明书.如果问題还不能解决,您可以跟我们的经销商联系解决.您也可以登陆我们的服务中心网站:

[HTTP:WWW.FLYSKY-CN.COM](http://www.flysky-cn.com)

3.THE SPECIAL SYMBOLS

Please pay attention to the following symbols when it appears on the manual, and read carefully.

此说明书中有如下符号的地方请您特别注意，并仔细阅读。



Danger:

If the operator does not operate by following the instructions, the operator may lead to serious injuries, even mortal danger.

如果操作者不按正常操作方法操作，可能导致操作者严重受伤，甚至致命危险！



Warning:

If the operator does not operate by following the instructions, the operator may lead to serious injuries, even mortal danger.

如果操作者不按正常操作方法操作，可能导致操作者严重外伤，重伤或者致命情况！



Attention:

If the operator does not operate by following the instructions, the operator may lead to minor injuries, but generally it will not cause serious injuries to the operator.

如果操作者不按正常操作方法操作，可能会导致操作者轻伤，但一般不会对操作者造成重伤！



Prohibition

禁止



Mandatory

强制

4.SAFETY GUIDES



Don't fly in night ,bad weather such as rainy or thundering days .It will interfere the transmitter signal. Thereby it will create out of control and unexpected accident .

请您不要在夜晚，刮风或下雨时使用，因为这样的天气环境会对遥控设备产生干扰，从而导致失控而产生意外！



Before you fly, please make sure the movement of server correspond with the direction of joysticks. If inconsistent, please adjust before fly.

在飞行前，请您务必先检查伺服器的各项动作是否与对应操纵杆的方向一致，如果不一致，请调整后使用。



You need to turn the throttle channel(ch2) and inching switch to the lowest before You use. Then switch on the transmitter power ,finally connect the receiver.

开机使用时请您务必先将油门通道（CH2）及微调置最低端。然后打开发射机电源并检查电源电量，再接通接收机电源。



The sequence to shutdown is that turn off the receiver power first, and then the transmitter power.

If the above operations are reverse, it might lead to uncontrolled and cause Accident.

停止使用前请您先关闭接收机电源然后关闭发射机电源。

以上操作如果反向，可能导致失控，从而产生意外！



MODELS: FS-GT2B

Digital proportional radio control system

5.2. 4GHZ SYSTEM



AFHDS
AUTOMATIC FREQUENCY
HOPPING DIGITAL SYSTEM

AFHDS(自动跳频数字系统), 这个系统是富斯公司专为模型爱好者自主研发, 并具有自主知识产权的一套数字无线系统。它是专门针对模型产品而研发的, 它具有超强的主动和被动抗干扰能力及极低的使用功耗和极高的接收灵敏度, 是目前市面上最好的系统之一。此系统经过研发人员极端严格的测试及多年市场验证, 模型爱好者完全可放心使用!

AFHDS (automatic frequency hopping digital system), is developed by FLYSKY for all the Radio Control model lovers and is patented by FLYSKY at home. The system is specially developed for all the Radio control models, that offers super active and passive anti-jamming capabilities, very low power consumption and high receiver sensitivity. With extreme rigorous testing by engineers and studying the markets for years, FLYSKY AFHDS is now considered to be the one of the best systems available in the market.

参数说明:

频率范围: 2.40-2.4835GHz;
波段宽度: 500Hz;
波段个数: 160个;
发射功率: 不高于20dBm (100mW)
2.4G模式: 自动跳频数字系统;
编码方式: GFSK;
天线长度: 26毫米;
接收灵敏度: -105dBm

Specifications:

RF range:2.40-2.4835GHz;
Bandwidth:500Hz;
Band sum:160;
RF power:less than 20dBm(100mW);
2.4G system:AFHDS;
Code type:GFSK;
ANT length:26mm;
RX Sensitivity:-105dBm;

系统特征:

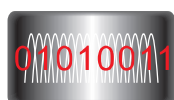

多频点跳频工作:

此系统工作波段为2.40GHz到2.4835GHz, 分160个频点, 每个系统使用其中不同的160个频点工作及160种跳频频率, 从而通过开机时间不同及跳频频率不同和使用频点不同, 尽最大可能使使用者的之间不会同频, 从而主动避开同频的干扰。

The system works in between 2.400GHz to 2.4835GHz frequencies that have been divided into 160 frequency points. Each system uses 16 frequencies points and 160 hopping frequency. By using various switching-on time, frequency hopping and different frequency points, the system can passively avoid frequency jamming.



全角度增益天线:

此系统采用的是线性优良的全波段的增益天线, 天线带宽覆盖整个波段宽度, 可大大提升系统发射效率及接收的灵敏度。从而提升系统的稳定性, 并加强了自身被动抗干扰能力。

The system uses a linear spread of fine paragraph by excess antenna, which covers the entire band width of the antenna bandwidth range, greatly enhances the efficiency of the system launch and receiving sensitivity. It greatly improves system stability, and strengthen the passive anti-jamming capability of the system.



独立身份识别系统:

此系统每个发射机都具有唯一的身份识别ID码, 当与接收机进行对码后此ID码被存放在接收机内, 当接收机工作时首先会验证此ID码是否正确, 然后才工作, 否则不会工作。此项可加大系统的主动抗干扰能力, 从而提升系统的稳定性。

Each transmitter has its own unique ID. When the transmitter communicates with the receiver, the ID will be transmitter and saved in the receiver. The System works only when the ID is matched when the receiver powers on. This dramatically increases the ability of passive anti-jamming and enhances the total stability of the system.



低功耗工作:

此系统完全采用超低功耗器件, 且接收采用高灵敏度的接收芯片, 工作时采用间隔发送方式。从而降低了发射功率, 并提升了使用工作时间。此系统使用功耗相当于以前FM版本的十分之一。

The system uses low power consumption components, and the receiver chip is extremely sensitive; the system uses interval signal transmission, thereby reducing the transmission power, and increasing the operating. Comparatively this system consumes only one tenth of the normal FM system.

6. BATTERY CHARGING NOTES



If your transmitter, receiver using a nickel-cadmium, nickel-metal hydride rechargeable battery, you have to well-check before you use. If lack of electricity, it could happen those phenomenon like inadequate control or out of control, resulting accident. So please charge immediately when the battery lacks of electricity.

如果您的发射机、接收机使用的是镍镉、镍氢等可充电电池,在使用前请您务必检查电池电量.如果电量不足,可能导致控制距离不够或者失控的现象,从而产生意外.所以电池电量不足时请及时充电.



If you are using a nickel-cadmium, nickel-metal hydride batteries for recharging, please use our company dedicated charger. If the electrical current is too large and it may lead to temperature over-heated and cause fire burning accident. Please cut off the power supply immediately after recharging. Please take out the battery from the transmitter when you are not using it within a period, it is because the battery may damage the aircraft batteries, thus being exposed.

如果您使用的是镍镉、镍氢电池进行充电,请您使用我们公司的专用充电器.因为如果充电电流太大可能导致电池温度太高,从而燃烧起火带来意外.充电完成请您及时切断电源.当您长时间不使用时请您电池从发射机中取出,因为电池可能导致发射机电池片损坏,从而接触不良.

DC(Direct Current) charging:

1. Install one side of the charger to the power connector, while the other side to the port of the USB (as picture 1), charge indicator turns red at this time;
2. Cut off the power supply after the process of charging completed. (The indicator light on the transmitter turns into green.)

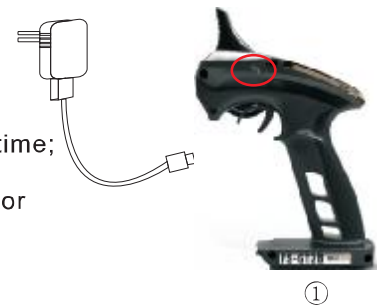

直流充电

将充电器插入电源接口, 另一端插入发射机的USB充电接口(如图1), 此时充电指示灯变成红色;
充电完成后, 发射机上的充电指示灯为绿色, 即可切断充电电源。

Charging by computer:

1. Install the rechargeable battery to the transmitter.
2. Install one side of the software to the port of USB on the computer, while the port of the USB on the transmitter. (as picture 2), charge indicator turns red at this time;
3. Take out the software after the process of charging completed. (the indicator light on the transmitter turns into green.)

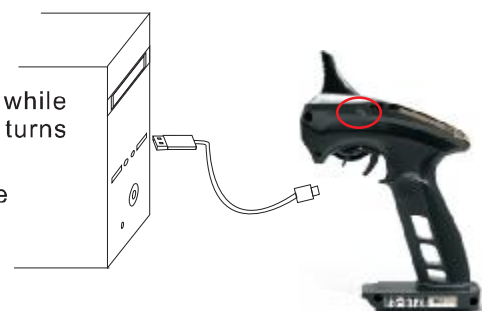

电脑充电

将可充电电池按方向装入发射机;
将数据线一段插入电脑USB插孔, 另一端插入发射机USB插孔(如图2), 此时充电指示灯变成红色;
充电饱和后, 发射机上充电指示灯为绿色时, 将其数据线拔出。

6.01.2 Charging by charger:

1. Install the rechargeable battery to FS-BC101.
2. Install one side of the charger to the power connector, while the other side to FS-BC101, or connect with the USB port of the computer directly, then the indicator of charger will turn to red;
3. When the indicator light on the charger turns into green, it means that the charge completed.
4. Cut off the power supply.

充电器充电

将电池按方向装入(FS-BC101;)

将充电器插入电源接口，另一端插入 (FS-BC101) 充电器，或者直接连接电脑USB，此时充电指示灯变成红色；

充电器上的充电指示灯显示绿灯时，充电已完成；

充电完成后，即可切断电源。

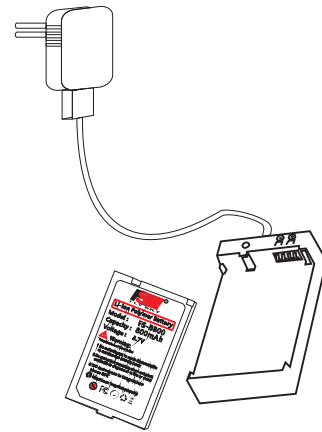

6.02 Receiver charger:

- A. Connect the charger to the commercial power connector.
- B. Connect the Rechargeable receiver with battery charger
- C. Recharge completed, cut off the power supply immediately.

1. 将充电器插入市电接口；
2. 将可充电接收机用电池接口与充电器充电接口连接；
3. 充电完成后，即时将电源切断。

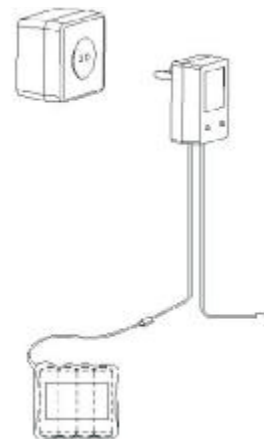

1. TRANSMITTER PARAMETERS

Specifications:

机种参数:

- 1.通道个数: 3个通道;
- 2.适合机种: 车、船;
- 3.发射功率: 小于等于20dBm (100mW);
- 4.调制方式: CFSK;
- 5.系统模式: AFHDS;
- 6.数据分辨率: 1024级;
- 7.低电压报警功能: 有(低于3.7伏后);
- 8.数据输出接口: 有(3.5英寸);
- 9.充电接口: 有(USB);
- 10.电源标准: 3.7V(800毫安锂电);
- 11.整机重量: 270克;
- 12.天线长度: 26毫米;
- 13.外型尺寸: 156*223*94毫米;
- 14.外观颜色: 黑色;
- 15.安规认证: CE、FCC.

SPECIFICATIONS:

- A.Channels:3channels;
- B.Model type:car/boat;
- C.RF power:no more than 20dBm(100mW);
- D.Modulation:GFSK;
- E.System type:AFHDS;
- F.Sensitivity:1024;
- G.Low voltage warning:yes(less than 3.7V);
- H.DSC port:yes(3.5mm);
- I.Charger port:yes USB;
- J.Power:3.7V(800mAh)
- K.Weight:270g;
- L.ANT length:26mm;
- M.Size:156*223*94mm;
- N.Color:black;
- O.Certificate:CE、FCC.



FS-GT2B



2. RECEIVER PARAMETERS

Specifications:

机种参数:

- 1.通道个数: 3个通道;
- 2.适合机种: 车/船;
- 3.接收灵敏度: -105dBm;
- 4.调制方式: GFSK;
- 5.系统模式: AFHDS;
- 6.数据分辨率: 1024级;
- 7.失控保护功能: 有(第2通道);
- 8.对码接口: 有(第3通道);
- 9.电源接口: 有(VCC);
- 10.电源标准: 4.5-6.5VDC(1.5伏*4);
- 11.整机重量: 5克;
- 12.天线长度: 26毫米;
- 13.外型尺寸: 37.6*22.3*13毫米;
- 14.外观颜色: 黑色;
- 15.安规认证: CE、FCC.

SPECIFICATIONS :

- A.Channels:3channels;
- B.Model type:car/boat;
- C.RF receiver sensitivity:-105dBm;
- D.Modulation:GFSK;
- E.System type:AFHDS;
- F.Sensitivity:1024;
- G.Faisafe:yes(channel 2);
- H.Bind port:yes(channel 3);
- I.Power port:yes(VCC);
- J.Power:4.5-6.5VDC(1.5V*4);
- K.Weight:5g;
- L.ANT length:26mm;
- M.Size:37.6*22.3*13mm;
- N:Color:black;
- O:Certificate:CE、FCC.



MODEL: FS-GR3C



9. RECEIVER CONNECTIVITY

9.01 Installation when a motor controller is used

带马达模型的安装连接

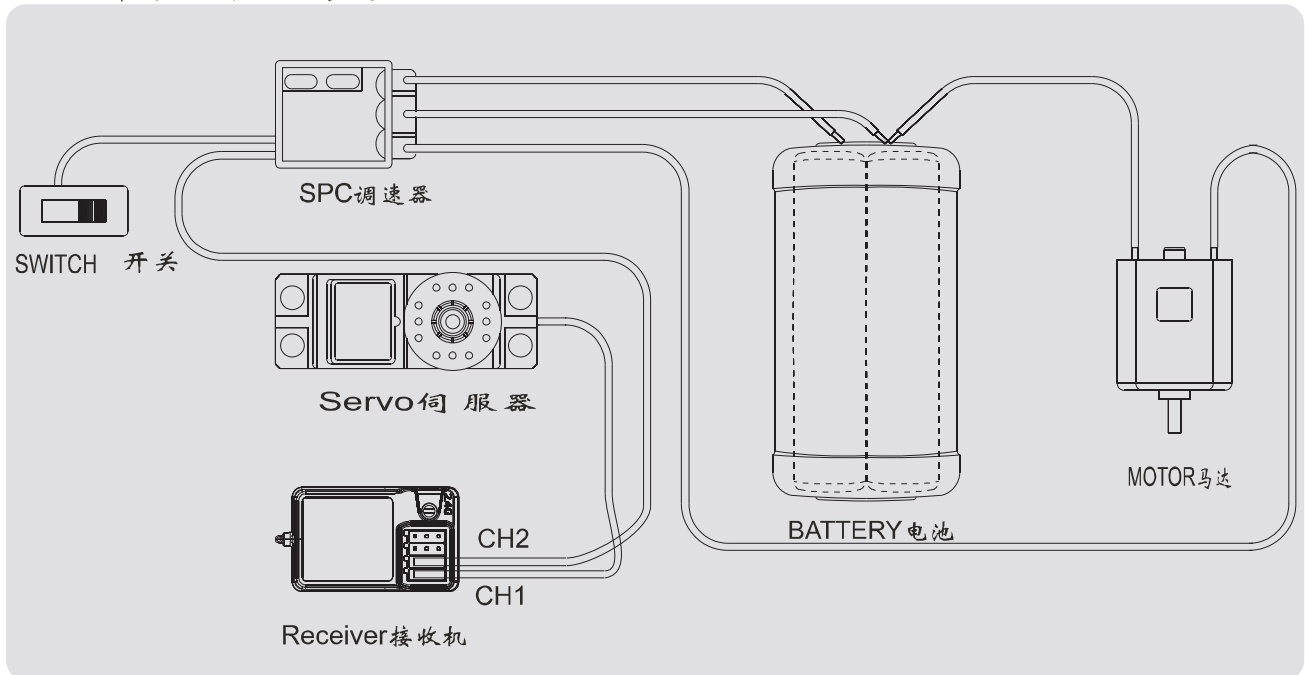

Remark: Place the antenna of the receiver vertically with the plane!
And don't let it close to the metal thing for assuring its sensitivity. (See pic1)
注: 在安装接收机时请将接收机天线与水平面垂直放置! 且天线尽可能不要靠近金属物! 因为这样接收灵敏度最高。(如图1)

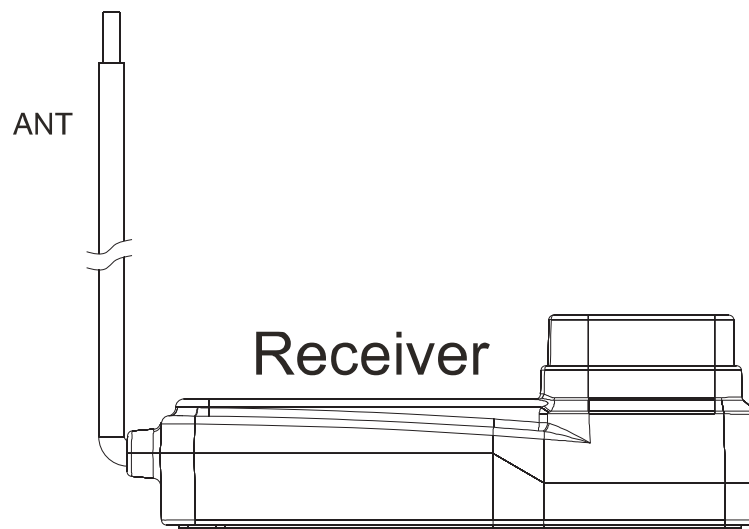
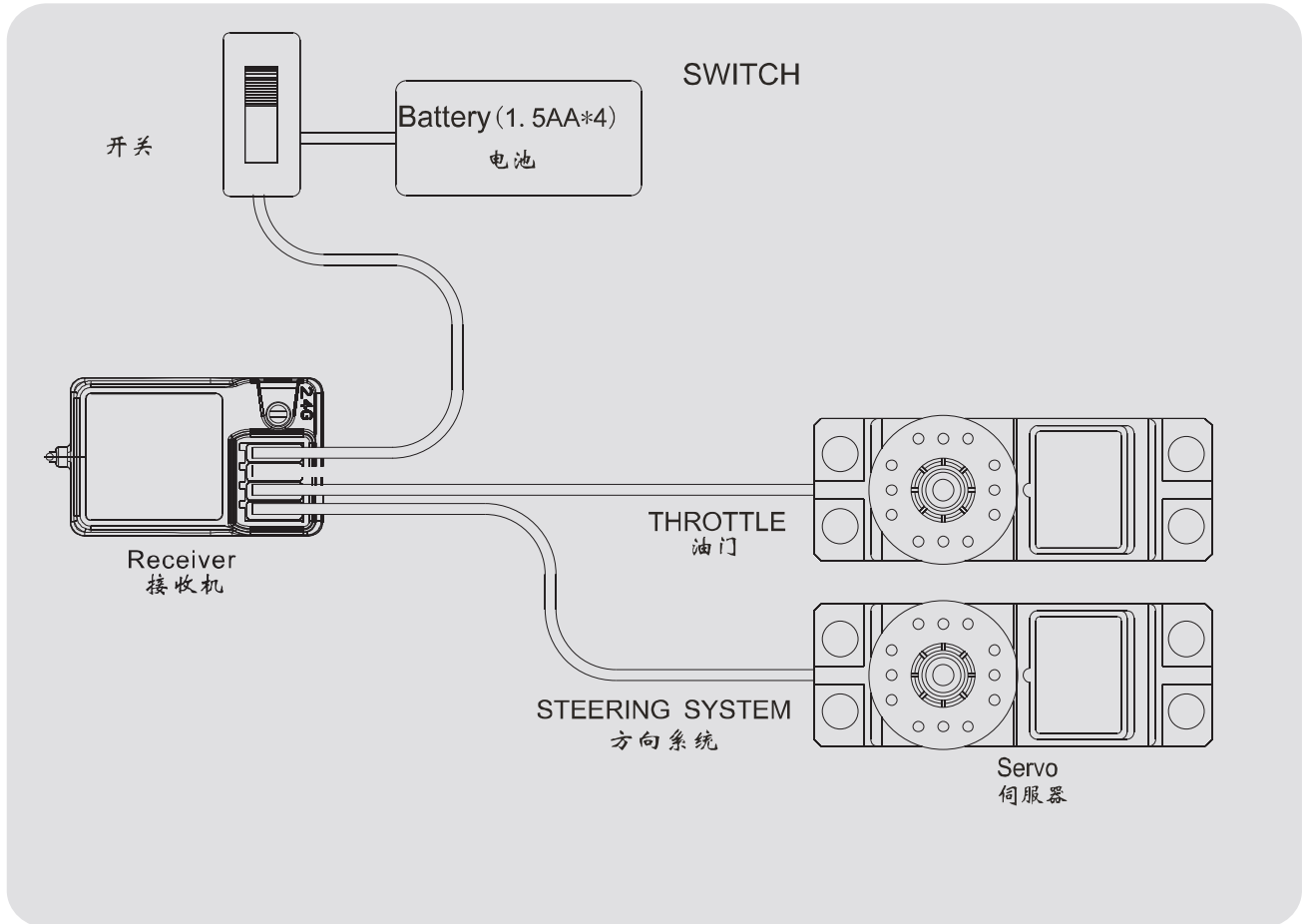

Figure 1 (图1)

9.02 installation for gas powered models

发动机模型的安装



10.2.4G OPERATION NOTES

10.01 Matching (code)

Our products are well matched in the factory, you do not need to match by yourself. But if you are going to match the receiver with other transmitter, or you need to change a new receiver or transmitter, please follow the following steps:

- A. Install the battery to 2.4G transmitter and shut it down.
 - B. Insert the matching lines to the channel BIND / CH3 port of the receiver. (Figure.1)。
 - C. Connect the receiver battery to VCC port of the receiver, on the same time the two LED are flashing and this means the receiver are going to the matching status.
 - D. Press and hold the button on the transmitter, and then switch on the power supply.
 - E. Observe the LED on the receiver, if find that the LED is not flash anymore and that means successful Matched. (This process about 5s)
 - F. Release the match button on the transmitter, take out the match line.
 - G. Install the server and then test.
 - H. If the tests fail, please repeat the action above.
 - I. If the tests success, then insert the power supply port into VCC, match complete.
- (The above ways of match is only suitable for FLYSKY 2.4G products)

我们的产品出厂前已经过配对，您无需做配对动作便可使用。但如果您要将接收机跟另外的发射机进行配对使用，或者您要更换新的接收机或者发射机，请您按如下的步骤进行：

注：我们的接收发射系统，不跟其它品牌兼容！

- 1.将2.4G发射机装好电池，并关闭发射机。
- 2.将配对线插入接收机的BIND/CH3通道接口（如图1）。
- 3.将接收机电池插入接收机的VCC通道接口，此时可看到接收机的LED在闪烁，此表示接收机进入配对状态。
- 4.将发射机上的配对键(BIND)按住，然后打开发射机电源开关。（注：不要松开按键）。
- 5.观察接收机上的LED，如果发现LED不再闪烁表示配对成功。（注：此过程大约时间为5S左右）。
- 6.松开发射机上的配对按键，拔掉接收机上的配对线。
- 7.将伺服器装上并通电测试。
- 8.如果测试NG，则重复以上动作。
- 9.如果测试OK，则将电源接头插入VCC，配对完成。

注：以上配对方法，仅适合于FLYSKY的2.4G产品。

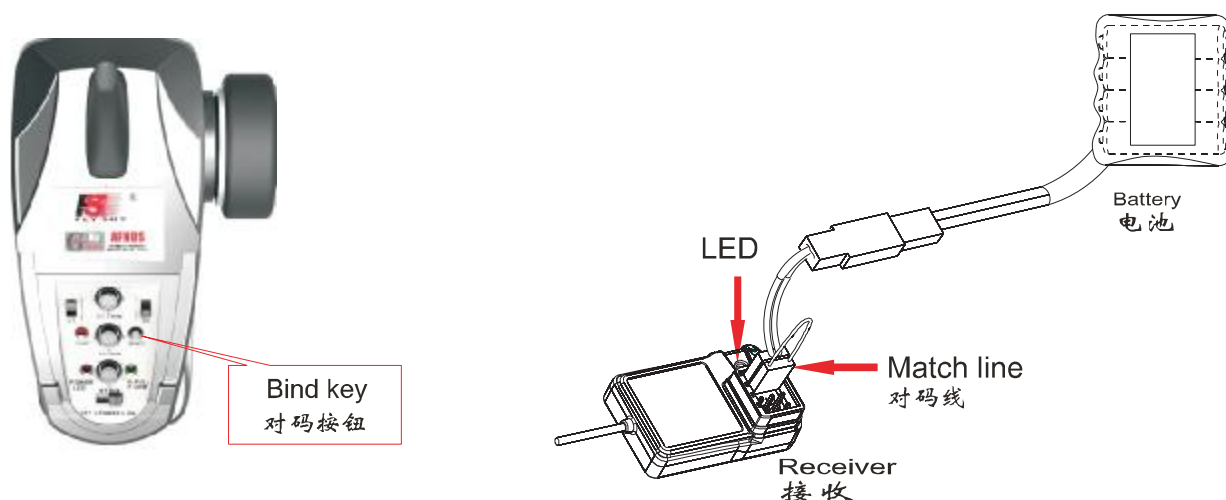

Figure 1 (图1)

10. 02 Power on:

- A. Connect every part.
- B. Switch on the power supply of the transmitter.
- C. Connect the power supply of the receiver.
- D. Receive LED light solid.
- E. Finish and use.

- 1. 将各部件连接好;
- 2. 打开发射机电源开关;
- 3. 连通接收机电源;
- 4. 接收机LED恒亮;
- 5. 使用.



Tx power ON

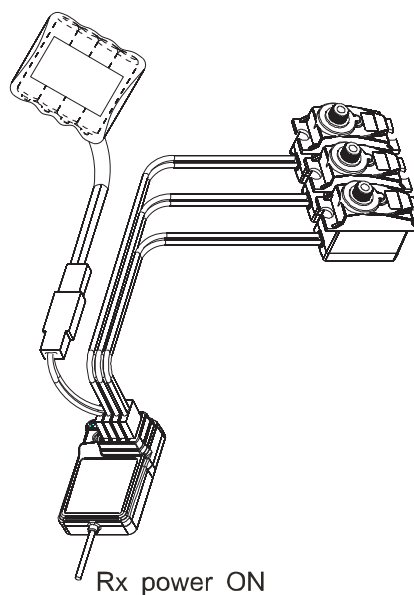
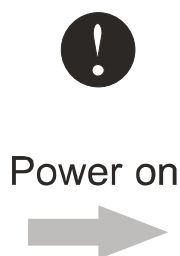

Rx power ON

10. 03 Shut down:

- A. Cut off the receiver power supply.
- B. Cut off the transmitter power supply.

- 1. 关闭接收机的电源;
- 2. 关闭发射机的电源.

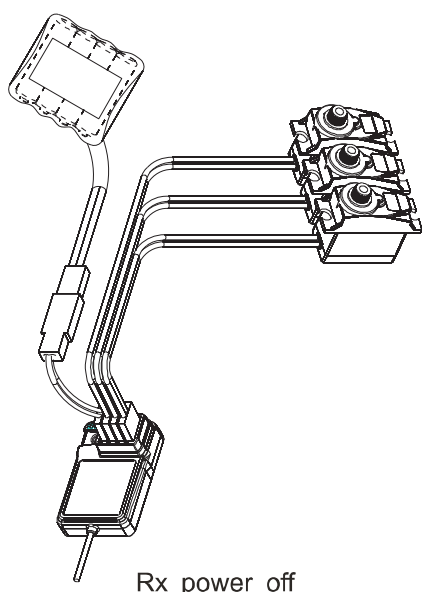

Rx power off

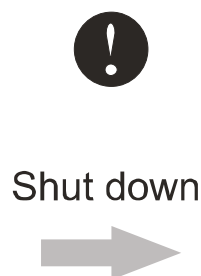

Tx power off

II. EACH PART OF THE TRANSMITTER

FRON



- ① CONTROL BOX
- ② 2.4G ANT
- ③ STEERING WHEEL
- ④ THROTTLE TRIGGER
- ⑤ BAT BOX

SIDE

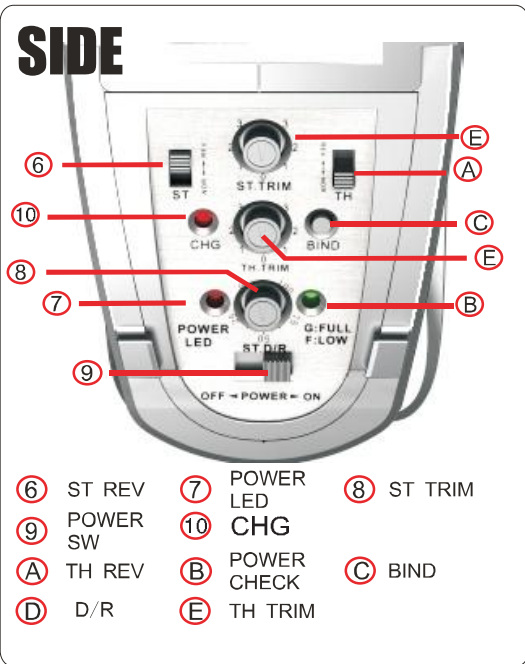

- ⑥ ST REV
- ⑦ POWER LED
- ⑧ ST TRIM
- ⑨ POWER SW
- ⑩ CHG
- A TH REV
- B POWER CHECK
- C BIND
- D D/R
- E TH TRIM

BACK



- F USB

12. TRANSMITTER FUNCTION NOTES

12.01 方向舵控制:



功能说明:

此功能是用来进行方向控制, 当方向舵往右旋转时车子前轮会跟着往右 (如图), 当方向舵往左旋转时车子前轮会跟着往左 (如图)。

操作方法:

开机后, 通过方向舵进行方向控制, 方向舵动作大小依据实际情况进行比率调整. 方向舵大小动作量可通过D/R进行大小舵量的调整。

Function Introduction:

This function is to control the direction, when the steering turn to right then the front wheel will turn to right (as picture), when the steering turn to left then the front wheel will turn to left (as picture).

Operation Method:

Adjust the dual rate of the steering by adjusting the D/R knob.

12. 02油门控制:



功能说明:

此功能是用来进行油门(速度)控制,当油门扣机往后打时车子会向前加速(如图),当油门扣机往前推时车子会进行刹车或加速后退(依据不同的调速器)(如图)。

操作方法:

开机后,通过油门扣机进行前后运行的控制。

Function Introduction:

This function is to control the throttle speed, when pull the throttle trigger back, car will accelerate forward (see the picture), when push the throttle trigger, the car will put on the brakes or double ring astern (according to the different ESC) (see the picture).

Operation Method:

To control it by pushing and pulling back the throttle trigger after power on.

失控保护功能说明

1. 功能说明

失控保护功能是对模型车或船进行失控保护，避免因失控造成损失。主要是对油门通道进行控制，当接收机接收不到控制信号时，接收机的油门通道将自运行到当初设定的值，以免误动作。

2. 设定方法

- 将发射机开通电源进入工作状态。
- 将接收机接通电源进入工作状态，此时信号灯恒亮。
- 控制发射机的油门通道，使油门控制伺服器或调速器进入刹车或熄火状态，然后保持不动。
- 此时将接收机的设定键（如图按下），此时接收机LED信号灯会闪烁，并在3秒左右停止。
- 设定完成。

3. 测试

- 将发射机打开进入工作状态。
- 将接收机接通电源进入工作状态。
- 将发射机关闭电源。
- 此时可看到油门通道的伺服器便会自动进入设定状态的位置。
- 以上动作如果可以完成表示设定OK

FAIL SAFE FUNCTION

1. Function

Failsafe aims to prevent out-of-control driving of RC Car or RC Boat. If the Receiver is not able to receive any signal, from the control to Throttle, the parameter of Throttle on Receiver will turn back to its original setting.

2. Setting

- Turn on the Transmitter switch;
- Turn on the Receiver switch, the LED will be lighting;
- Adjust Transmitter's Throttle, make the car/boat to stop or flameout, then keep still.
- Press the "Setting" button on Receiver (as the pic below), the LED will be flashing, then stop after 3seconds around, which means setting finished.

3. Testing

- Turn on the Transmitter switch;
- Turn on the Receiver switch;
- Turn off the Transmitter switch;
- Servo of Throttle will turn back to its original setting automatically;
- Setting is successful if above procedures finished completely.



14. SIMULATE

功能说明:

此功能用于电脑模拟，从而可通过电脑进行练习，及进行电脑模拟比赛。

操作方法:

1. 将本厂提供的电脑模拟连接线(FS-SM100)一端插入发射机的DSC接口，另一端插入电脑的USB接口，
2. 打开发射机电源。
3. 启动VRC车模应用软件。
4. 按软件要求进行设定完成后便可进行电脑模拟了。

备注:

本公司提供的是VRC公司的免费软件，此软件只提供一条基本赛道和一个训练场。如需其它赛道请跟VRC公司联系。谢！

Function Introduction:

This function is for the virtual RC racing through the computer, you can practise the racing from the computer.

Operation Method:

1. Hook up the DSC port of your Transmitter to the USB adaptor (fs-sm100) and plug the USB adaptor into your PC notebook.
2. Turn on the Transmitter.
3. Open the VRC software.
4. Follow the on-screen instruction to set.





Remark:

The VRC software we provided is free which is offer only one basic track and training ground. If you need any other track, please contact VRC Company, thank you!



TO COMPUTER USB PORT
MODEL NO: FS-SM100

16 .PACHAGING WITH CONTENT LIST

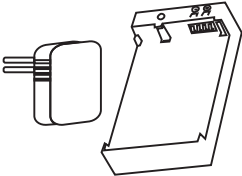
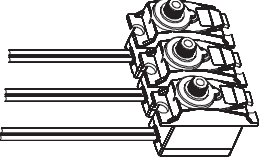
NO:	Model	Sum	Remarks
1	2 channel 2.4G transmitter (FS-GT2) 2通2.4G发射 	1	
2	3channel 2.4G receiver (FS-Gr3C) 3通2.4G接收 	1	
3	MANUAL 说明书 	1	CD
4	数据线 (USB) 		
5	锂电池 (800mAh) 		
6	Charger 充电器 	1	Optional 可选的
	Servo (FS-S009) 伺服器 	2	Optional 可选的



Digital proportional radio control system

CE FC

[Http://www.flysky-cn.com](http://www.flysky-cn.com)
Copy right 2008@flysky co., ltd