

POLARON EX

2 Channels DC Charger

Graupner | SJ

OPERATING INSTRUCTION

Please read this manual thoroughly.

Keep this manual in a convenient place for quick and easy reference.



Graupner | SJ

- CONTENTS -

• BEFORE USE	4
• SUPPORT AND SERVICE	4
CUSTOMER SUPPORT	4
INTERNET SALES SITE / FIRMWARE UPGRADE	4
A/S SUPPORT	4
WARRANTY INFORMATION	4
• OPENHOBBY A/S SUPPORT AND SERVICE CENTER.....	4
• BOX CONTENTS	5
• SAFETY PRECAUTIONS	5-6
• SPECIFICATIONS	7-8
• CHARGER CONTROL IDENTIFICATION	9-10
• MENU CONFIGURATION	11
ACTION BUTTONS	11
MENU DESCRIPTION	11
• BATTERY CONNECTION	11
• INPUT POWER SETUP	12
• MAIN PAGE	12
• PROFILE PAGE	12-13
DISPLAY	13
BATTERY NAME EDITING	13
• CHARGE PAGE	14-19
LiPo, Lilon, LiFe BATTERY CHARGE SETUP	14
NiCd/ NiMH BATTERY CHARGE SETUP	15
Pb BATTERY CHARGE SETUP	15
LiPo, Lilon, LiFe, NiCd, NiMH, Pb BATTERY CHARGE PROCESSES.....	16
CHARGE MODE PER BATTERY TYPE	16-18
• DISCHARGE PAGE	20-23
LiPo, Lilon, LiFe, NiCd, NiMH, Pb BATTERY DISCHARGE MODES	20
LiPo, Lilon, LiFe, NiCd, NiMH, BATTERIES DISCHARGE PROCESSES	21
DISCHARGE MODE PER BATTERY TYPE	21-22
• CYCLE PAGE	23-27
LiPo, Lilon, LiFe, NiCd, NiMH, Pb BATTERY CYCLE PAGES	24
LiPo, Lilon, LiFe, NiCd, NiMH, Pb BATTERY CYCLE PROCESSES	24
CYCLE OPERATION MODE PER BATTERY TYPE	25
• BALANCE PAGE	27-28
• DATA VIEW PAGE	28-29
• USER SETUP PAGE	29-30
• MISC PAGE (ADDITION FUNCTION)	31
SERVO AND BRUSHLESS MOTOR TESTING SETUP	31-33
BRUSHED MOTOR SETUP	34-35
WARMER SETUP	35-37
SPEED CONTROLLER SETUP	37-38
• FACTORY SETUP AND SCREEN CALIBRATION	39-41
DATA INITIALIZATION	40
TOUCH CALIBRATION	40
RESOURCE UPGRADE	41
BLC PORT TEST	41

• SLAVE BOARD UPGRADE (PRODUCT UPDATE)	41
• ERROR MESSAGES	42-44
• COMMON PROBLEMS AND PRECAUTIONS FOR THE POLARON EX DC CHARGER	45
• NiCd/MH BATTERY SAFETY	46
• Pb BATTERY SAFETY	46
• Lilon, LiPo, LiFe BATTERY SAFETY	46-47
• THE GUIDE FOR THE RELATED COUNTRIES' CERTIFICATIONS	48
• ENVIRONMENTAL PROTECTION NOTES	48

© BEFORE USE

Thank you for purchasing the POLARON EX 2CH DC Charger. Designed for both novices and professionals, this system is extremely versatile. To make the best use of your system, please read this manual carefully.

For any difficulties with your system, we offer multiple resources to assist you, including this reference manual, an online Frequently Asked Questions webpage (www.openhobby.com), your hobby dealer, or the Graupner/SJ Service Center (contact information below).

Due to unforeseen changes in production procedures, the information contained in this manual is subject to change without notice.

© SUPPORT AND SERVICE

• Customer support

We are happy to assist you with any question by e-mail or phone. Customer service hours are from 9 am to 5 pm PST (Pacific Standard Time) during the workweek, Monday through Friday. E-mailed questions will be answered as soon as possible.

• Internet sales site / Firmware Upgrade

Please visit us at www.openhobby.com, to stay up to date with the latest software and firmware for your products.

• A/S support

During the warranty period, we can repair this product at no cost for products that have become faulty under normal operating conditions. For non-functional products that are past the expiration date of the warranty or have been improperly used, we would be happy to repair this product for an appropriate amount of cost to the consumer, warranty period.

• Warranty information

Refer to the WARRANTY CARD in the Package.

© OPENHOBBY A/S SUPPORT AND SERVICE CENTER

3245 University Ave, Suite 1520
 San Diego, CA 92104, United States of America
 Phone: +1 855-5-RCisHoTT (+1 855-572-4746)
 Customer Service E-mail: service@openhobby.com

©2013 Graupner/SJ USA – OPENHOBBY LLC. The HoTT trademark is used with permission of SJ Inc. 4386066

© BOX CONTENTS

1. Charger
2. 7 Cells Balance board/Cable (EH to XH)
3. Temperature sensor (2pcs)
4. USB cable
5. Output cable with alligator clip (2 pairs)
6. Charger rack (optional)
7. User manual
8. Warranty card

© SAFETY PRECAUTIONS

- Do not attach the charger to both the AC and DC power sources at the same time.
- Never connect the input jack (DC input) to the AC power.
- Disconnect the docking power supplier while connecting the DC power source to the rear terminal of the charger.
- Program the input power setup correctly during the USER SETUP.
- During the USER SETUP, program the correct settings for the docking power supplier.
- CAUTION: Using an automobile battery as a power source can result in a complete discharge/ draining of the automotive battery.
- Supply sufficient power to the charger. The charger output has a maximum of 400W for each channel.

- If possible, place the battery in a safety bag during the charging or discharging process.
- Pay attention to the charger during use. Do not leave the charger unattended.
- If the charger becomes hot, disconnect the battery and remove the input power immediately. Allow the charger and the battery to completely cool down before reconnecting.
- Do not attempt to charge dead or damaged batteries.
- Use identical batteries in the charger.
- Do not attempt to charge a battery pack containing different types of batteries.
- Do not use a too short or damaged cables.
- Ensure that each channel has a completely charged pack.
- Do not use near a flammable object. Use only in well-ventilated areas. Explosive gases may be generated during the operation of this product.
- Do not reverse the positive and negative terminals. An incorrect connection will damage the batteries and may cause damage to the charger.
- Use only rechargeable batteries that meet the product specifications of this charger.
- Do not allow water, moisture or foreign objects into the charger.
- Do not use in humid locations. Do not operate with wet hands.
- Do not attempt to dismantle the charger.
- Do not use on fleecy materials, such as carpets, blankets, beds and cushions. Use on hard flat surfaces.
- Do not use in the extreme cold or heat, as the charger may not operate using the expected values, causing failures in the operation.
- Use in a well-ventilated location. Do not block the cooling fan (rear) and the air inlet (front).
- Ensure that the TFT panel is visible during the operation of this product. The TFT panel might not be visible under direct sunlight.
- We strongly recommend balancing Lithium packs. An unbalanced pack can cause damage and, in extreme cases, can cause a fire.

- Connect the battery pack to a balance board. Without this connection, either the batteries or the charger may be damaged.
- Do not charge a battery with a voltage below 2,8V per cell. If this type of battery is forced to charge, the pack can be damaged and, in extreme cases, can result in a fire.
- The default charging current is 1C. Monitor the voltage and the temperature of batteries during charging operations that may exceed 1C.
- Do not charge Lithium Polymer battery packs to values that exceed 4,2V per cell.
- Always disconnect the battery after charging. Allow the charger to cool between the charges.
- Do not charge the batteries inside a car. Never use a cigarette socket as a power source.
- Do not charge the batteries using a digital camera, a camcorder, or a cell phone, as the power source.
- Please use insulating gloves during the handling of the batteries, the charger or the wires. Failure to do so may cause personal injury, as the voltage differential between the input and the output can result in the formation of sparks.

© SPECIFICATIONS

MODE	SPECIFICATION
Power source	11–28V External DC Power Supply (Docking system)
Display	TFT 3,0" LCD W/ Touch screen
Battery Type & Cells	NiCd, NiMH / 1–14 cells / each channel
	LiPo, LiFe, Lilo / 1–7 cells / each channel
	Pb / 1–12 cells (2V/cell) / each channel
Output	2 Channels (400W x 2CH = 800W)
Charge Current	0,1 – 20,0A (100mA steps) / Max. 400W–24V; Max. 220W–12V
Discharge Current	0,1 – 10,0A (100mA steps) / Max. 60W
Cycling	Discharge, Charge to Discharge / Discharge to Charge / Charge to Discharge
Balancing current	Max. 350mA
USB	USB 5V output (5,0V 2,5A) / USB B-Type
Sub Function	Servo Test, Motor Test, Warmer, ESC setting
Firmware upgrade	External Mini USB device
PC communication	Graupner/SJ Logging Software
Languages	Optional (Primarily English)
Cooling system	50 x 50 x 10mm x 2ea Dynamic Cooling Fan
Ext. Module socket	Futaba 3P socket
Motor Test socket	ZHR
Servo Test socket	Futaba 3P socket
Memory	Each channel contains 20 memories (20ea x 2CH = 40 memories)
SMPS Docking Terminal	Yes
Dimensions	88,2 x 203,4 x 196,3 mm / 3,47 x 8,00 x 7,73 inches
Weight	1368 g / 48,25 oz

TOP

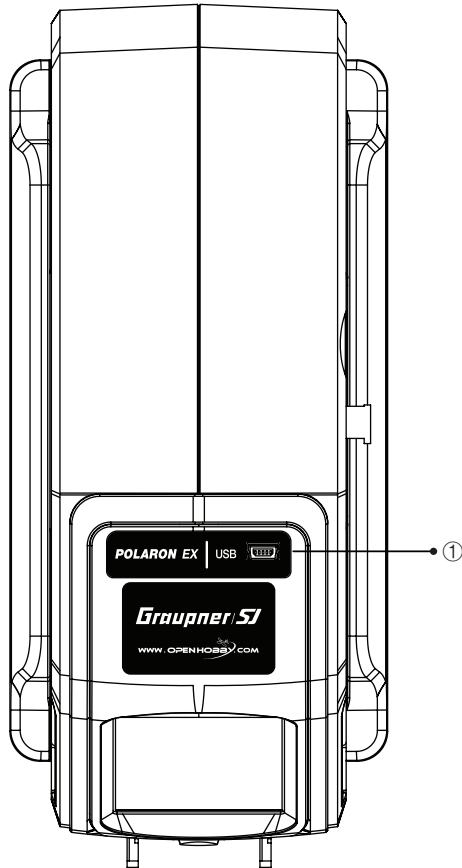

BACK

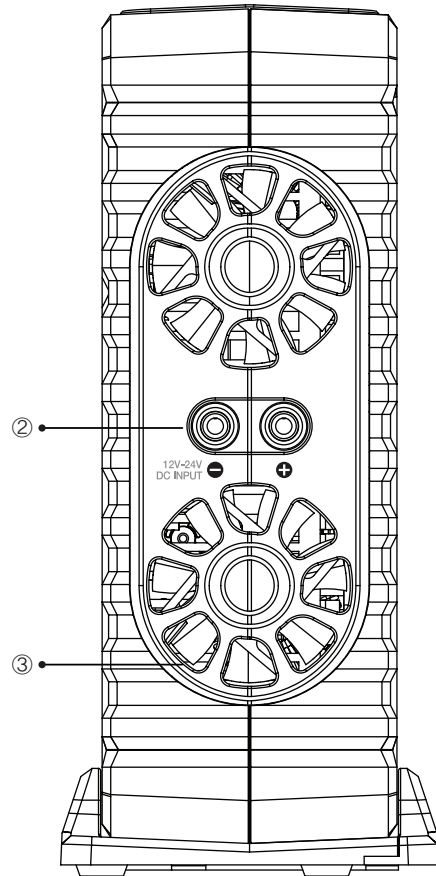

FRONT

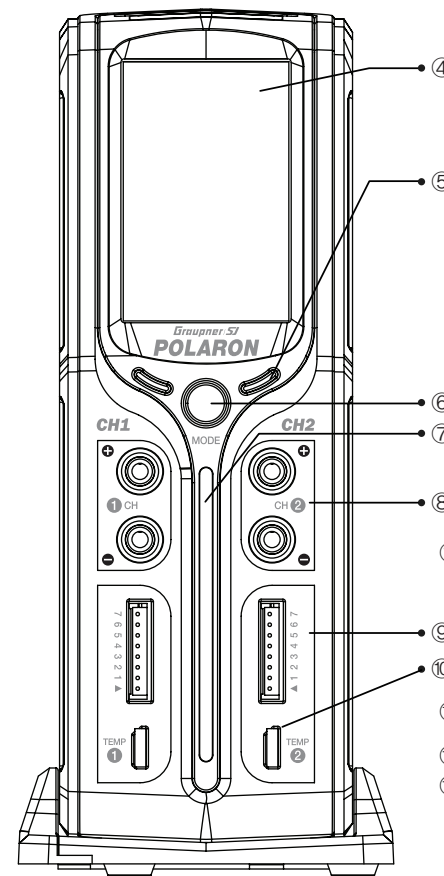

RIGHT

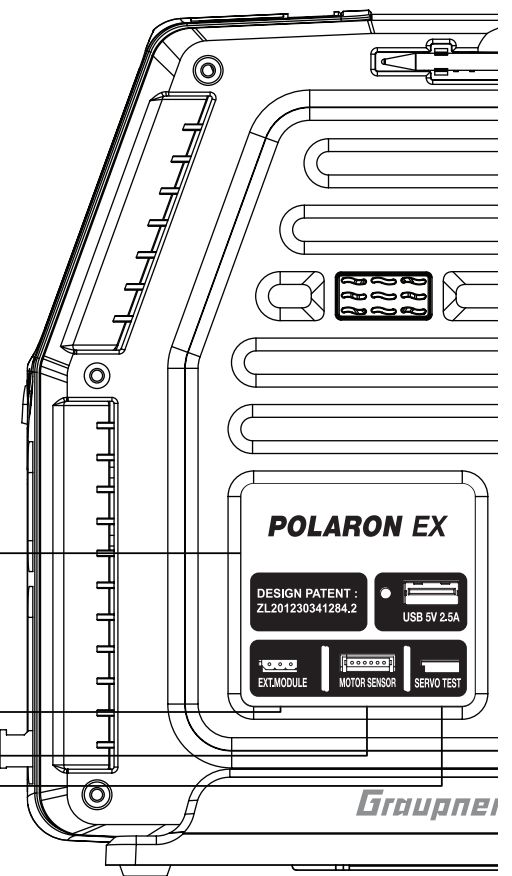

① Mini USB

② DC Input

③ Dynamic Cooling Fan
W/Speed control

④ 3.0" TFT LCD with Touch Screen

⑤ LED Indicator for charge / discharge

⑥ Channel selection button

⑦ Charge / discharge status LED bar

⑧ Battery socket

⑨ Balance port

⑩ Temperature sensor port

⑪ USB +5V 2.5A

⑫ Ext. Module / Speed Controller

⑬ Motor sensor

⑭ Servo test

Setting

◎ MENU CONFIGURATION

Graupner/SJ POLARON Series chargers are equipped with a highly sensitive touch screen. Touch the icons to access every mode and set up your device.

ACTION BUTTONS



– ESC button: Return to the previous page, store the setup data, etc.



– DEC button: Page transition, data setup, etc.



– INC button: Page transition, data setup, etc.



– ENTER button: Go to the next page, Complete the data setup, Start / complete the operation, store the setup data, etc.

MENU DESCRIPTION

Main page	Function
PROFILE	Battery name, type, capacity, number of cells, memory number, memory copy
CHARGE	Setup the battery charge data
DISCHG	Setup the battery discharge data
CYCLE	Setup cycle type and delay the time of charge / discharge (using the charge / discharge setup data)
BALANCE	Display the cell voltage and related data. Setup the balance data
DATA	Display the completed data and battery status
MISC	Setup servo, motor and warmer data, ESC setting
USER SET	Setup input data, warning, date, time, user name and etc.

◎ BATTERY CONNECTION

POLARON EX 2CH DC chargers have two sets of outputs on the front of the charger, Channel 1 is on the left, Channel 2 is on the right, Each channel has two 4mm banana sockets with a 7 cell balance port and a temperature sensor input port. An appropriate charge lead must be selected to match the specific connector on your battery. The charge leads must be connected to the 4mm output sockets on the specific charger channel, with the positive (+) lead connected to the red socket and the negative (-) lead connected to the black socket.



Only connect the battery to the charge lead AFTER the charge lead has been connected to the charger, as the connectors on the charge lead could touch together and cause the battery to short circuit.



During the charging of a Lithium pack, the balance lead MUST be connected to the charger. The charger has a 'JST-EH' type balance port, but also comes with other balance adaptor boards. To use an adaptor board, connect the supplied balance adaptor board lead to the charger. Then, connect the board using the appropriate battery balance connector. This balancing connector is essential. Without connecting the balancing connector to the balancing port on the charger (i.e., the main battery power leads ONLY are connected to the output banana sockets), the charger will charge or discharge the connected Lithium pack without balancing it. Balancing a Lithium pack is highly recommended. As some cells may retain more

◎ INPUT POWER SETUP

This charger has a capacity of 40 memories (CH1 20 /CH2 20). Each battery can be configured with the basic programming setup to manage the batteries efficiently. The charger should be connected to the docking SMPS or a suitable 11–28V DC power source, with the black lead connecting to the negative (-) and the red lead connecting with the positive (+) input voltage. The current can be programmed during the USER SET (ref. page 30) process. This charger will control the output automatically, depending on the power input source.



▲ Power on

◎ MAIN PAGE

– The channel numbers (accessed using the bottom boxes) can be used to select the channel. The main page of the selected channel is shown in red. Tapping the link to the other channel box will select for the other channel.

– The date and time are displayed on the top of the main page. This data can be programmed during the USER SET process.

– The links displayed on the main page can be accessed by tapping the images. Activated icons turn to a dark gray and the charger emits a beeping tone.



◎ PROFILE PAGE

The profile page is the main functional page for this charger. This page can be used to set up the battery name, battery type, capacity, number of cells and the memory number, as well as being used to initiate the charging, discharging, cycling and balancing mode functions. The related functions for the charge and discharge processes are operated according to the stored data of the charging, discharging, cycling and balancing modes.

• Display

Section 1

Section 2

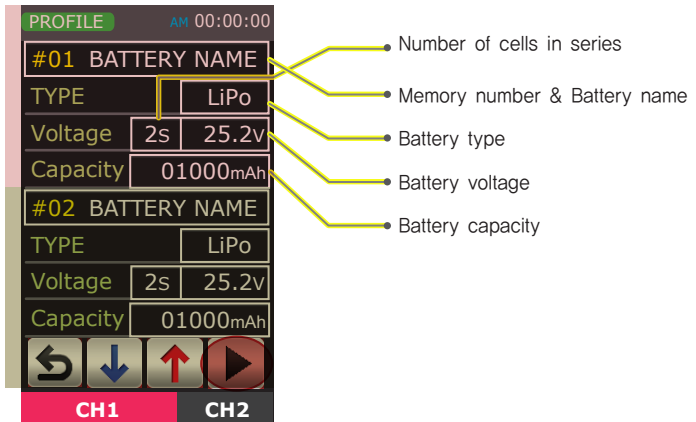

- 1) Tap the memory number box in section 1 to activate. Tap the INC/DNC buttons to set the memory number. The numbers 1–20 are available and changeable. Press and hold the memory number box to access the battery name page.
- 2) Tap the battery type, the number of cells and the capacity to activate these functions. Tapping the INC/DEC buttons can be used to edit the battery parameters.
- 3) Memory copy
Tap the number box in Section 2 to activate. Tap the INC/DNC buttons to set the memory number. Tap the Enter button to copy the battery parameters from Section 1 to the battery parameters for Section 2.
- 4) Tap Enter button to store the battery parameters and tap ESC button to get back to the previous page



IMPORTANT: The battery parameters must be entered correctly, as incorrect values may cause the charger to damage your battery, which can result in a fire!

• Battery name editing

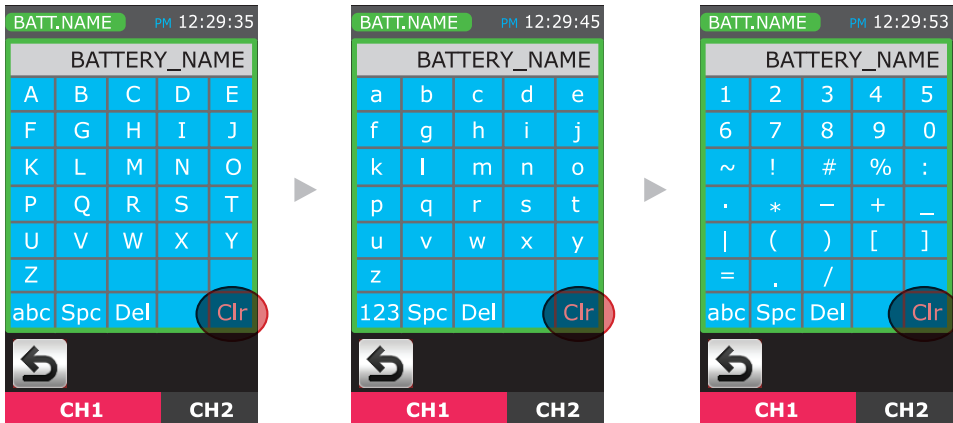

Battery names can be written with 12 characters. Tapping the Clr button (shown in the red circles, above) erases the default name, allowing the new name to be entered. To enter the battery names "ABC", "abc", or "123", each page with the upper case letters, the lower case letters and the numbers with special characters should be separately accessed by tapping the respective icons. Tapping the ESC button will return the screen to the previous page.

© CHARGE PAGE

To access the charge mode, tap the CHARGE icon on the main page. The parameters in this mode are dependant on the selected battery type that was set on the profile page.

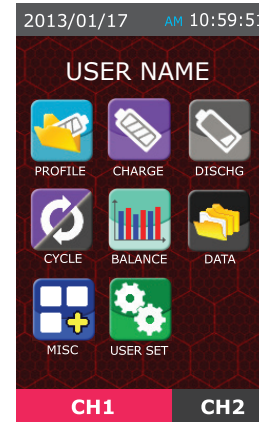

Tap the CHARGE icon on the main page to initiate the charging process.

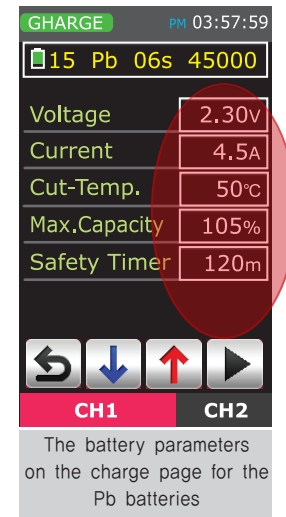
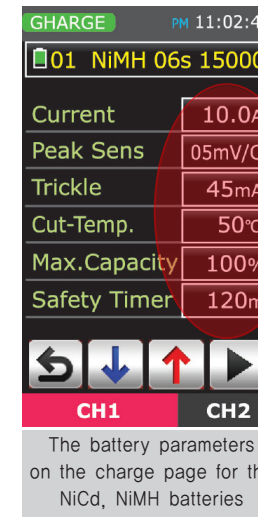
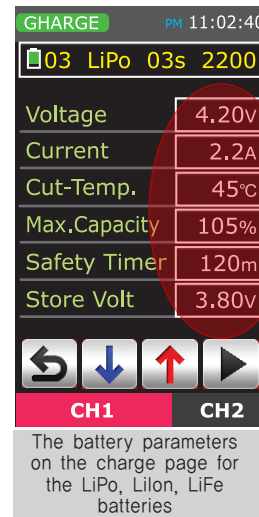

To program the battery parameters, tap each data box, activating to a blue color. To edit the battery parameters, tap the INC/DEC buttons.

• LiPo, Lilon, LiFe battery charge setup

- Voltage : Maximum cell voltage – CV (Constant Voltage)
- Current : Charge current, – Tapping the INC/DEC buttons can activate and edit the parameters The default charge current is set to 1C (1 x capacity). This value can be adjusted from 0,1 to 20 Amps, operating within the 400W limitation.

- Cut-Temp : Cut-off temperature. Detected using an optional temperature sensor, a safety cut-off temperature can be set to automatically terminate charging or discharging processes. This termination can occur for battery temperatures exceeding a preset value.
- Max Capacity : The maximum capacity setting is used to terminate a charge. The maximum capacity is used to prevent the battery capacity from exceeding a preset percentage. Damaged, poorly balanced, or improperly programmed batteries can be overcharged without this limitation.
- Safety Timer : The safety timer can be used to terminate a charge for charging times that exceed this preset time period. This timer can be used to protect the battery from damage.
- Store Volt : The battery voltage in the store mode. This parameter is used to terminate a charge for voltages that reach a preset voltage value.

• NiCd/ NiMH battery charge setup

- Current : Charge current. - Tapping the INC/DEC buttons can activate and edit this parameter. The default charge current is set to 1C (1 x capacity). This value can be adjusted from 0.1 to 20 Amps, operating within the 400W limitation.
- Peak Sens : Delta-peak cut-off voltage. - This parameter is used to charge the NiCd/ NiMH batteries. As the pack voltage peaks, the pack becomes hot and the pack voltage drops off. This charger terminates the charging process using a Delta-peak cut-off. The default parameter is 3mV/cell for the NiMH batteries and 7mV/cell for the NiCd batteries.
- Trickle : Trickle charge current. - With NiCd and NiMH type batteries, a trickle charge process is recommended after the main charge has completed, allowing the battery to become fully charged and ready to be used. The recommended trickle charge current is approximately 10% of the pack capacity (possible to set to a max of 500mA).
- Cut-Temp : Cut-off temperature. - Used with an optional temperature sensor, a safety cut-off temperature value can be specified, allowing the charging or discharging processes to automatically terminate for battery temperatures exceeding a preset value.
- Max Capacity : The maximum capacity setting is used to terminate charging processes for battery capacities exceeding the selected percentage values. Damaged or improperly programmed batteries can be overcharged without a proper setting of this parameter.
- Safety Timer : The safety timer can be used to terminate the charging process for charging times that exceed a preset time period. This timer is used to protect the batteries.

• Pb battery charge setup

- Voltage : Maximum cell voltage. - CV (Constant Voltage)
- Current : Charge current. - Tapping the INC/DEC buttons can activate and edit the parameters. The default charge current is set to 1C (1 x capacity). This value can be adjusted from 0.1 to 20 Amps, operating within the 400W limitation.
- Cut-Temp : Cut-off temperature. - Used with an optional temperature sensor, a safety cut-off temperature can be set, allowing the charging or discharging processes to automatically terminate at battery temperatures exceeding the preset temperature value.
- Max Capacity : The maximum capacity setting is used to terminate charging processes that result in battery capacities exceeding a preset percentage value. Damaged, poorly balanced, or improperly programmed batteries can be overcharged without this limitation.
- Safety Timer : The safety timer can be used to terminate the charging process for charging times that exceed a preset time period. This timer is used to protect the batteries.

The programmed data are stored in the memory and used to charge the batteries. Tapping the Enter button initiates the charging process. The balance connector verification, the charge mode verification, the number of cells to be charged, and the delay time setup should be finished prior to the charging process. For an improperly programmed setup, the charger will initiate a 5-second countdown without any external controls.

Below picture shows the sequence of charging

• LiPo, Lilon, LiFe, NiCd, NiMH, Pb battery charge process

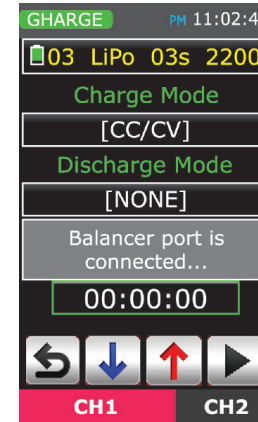

The charger verifies the connection with the balance board. This step is an automatic process.

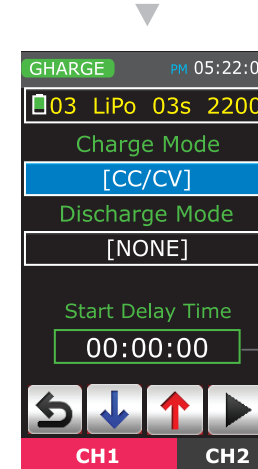

Charge mode selection

Both the charge mode and the delay time are programmed parameters. To activate, tap the box to become blue. Tap the DEC/INC button to select the desired mode. Charge modes are explained below

After a 5-second countdown, the charger initiates the charging process. Tapping the Enter button initiates the charging process immediately.

Delay time setup

The Start Delay Time can be set at values ranging from 1-150 minutes. The charger initiates the battery charging process after the preset time has expired.

• Charge mode per battery type

[AUTOMATIC]

NiCd/NiMH : This step is an automatic charging process, first determining the number of cells and then monitoring the charge current. The charger calculates the internal resistance and charge current for every period of time, automatically adjusting the charge current to ensure the delivery of the optimal charge current to your pack. The PEAK SENS values (NiCd=7mV/cell, NiMH=4mV/cell) are applied automatically. The CUT-TEMP values can be programmed.

[NORMAL]

NiCd/NiMH : The charger will charge the pack with a preset charge current, stopping the charging process every minute to calculate the voltage and detect the Delta peak. This process allows for improved peak detection, determining the amount of battery wear and instabilities in the charge cable.

[LINEAR]

NiCd/NiMH : The charger will charge the pack with the preset charge current, detecting the Delta peak every second without stopping the charging process. As changing the charge cable contact point might terminate the charging process, do not touch the charge cable during the charging process. After 10 minutes, the charger will stop charging for a few seconds to calculate the internal resistance. This method can detect the ZEROpk (0mV/cell) and terminate without an increase in the temperature.

[CC/CV]

Lilon/LiPo/LiFe/Pb : After charging with a constant current, the charger will then charge the pack with a constant voltage. The calculated voltage from the balance cable is used to control the process, allowing the pack to be charged safely (Only a battery equipped with a balance cable should be charged, excluding the Pb batteries).

[FAST]

Lilon/LiPo/LiFe : After charging with a constant voltage, the charger will charge the pack with a constant current. The calculated voltage from the balance cable is used to control the process, allowing the pack to be charged safely (Only a battery equipped with a balance cable should be charged, excluding the Pb batteries).

[STORE]

Lilon/LiPo/LiFe : After charging / discharging under constant current conditions, the charger will charge/discharge to store the pack with a constant voltage. CC/CV is applied to N-STORE, FAST is applied to Q-STORE.

Charge modes for the POLARON EX CHARGER

LiPo, Lilon, LiFe	CC-CV : Normal charge. FAST : Fast charge. N-STORE : Normal store charge. Q-STORE : Quick store charge. CV-LINK : The packs that have the same number of cells and capacity can be charged simultaneously (If the cells are different, errors can occur.)
NiCd, NiMH	AUTO : The charge will automatically adjust the charging conditions. NORMAL : Normal charge conditions. LINEAR : The preset current is maintained throughout the charge.
Pb	CC-CV : Normal charge.



In the CV-LINK mode, the packs should have the same voltage, capacity and number of cells. With variances in the charging parameters, damage to the batteries can occur. Please install a balance cable to CH1, CH2

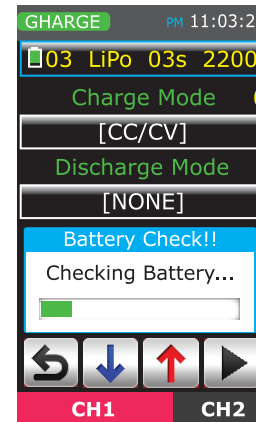

→ This page (left) demonstrates the battery check process after the balancer is connected. The next page is accessed automatically. Tapping the Enter button  will immediately cause the charger to initiate the charge process.

Battery Cell Check

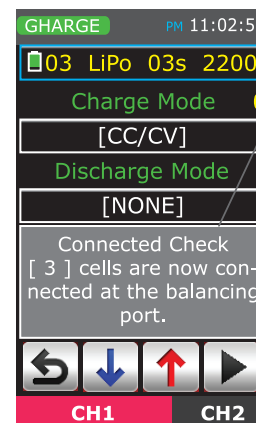

Number of cells check

After connecting the balance board, the charger can check the number of cells. If the reported number of cells is not correct, tap the ESC button to return to the previous page and re-run the parameters check again. Repeat this process until the number of cells is correct. With the correct parameters, the next page will be accessed automatically.

Without the balance board connection, the number of cells should be entered manually. Tapping the Enter button  will cause the charger to immediately initiate the charging process.

(This page does not appear for connections with NiCd, NiMH batteries.)

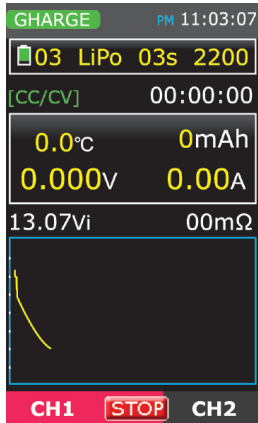

This page (left) shows the charging process with the parameters and graph. Both the voltage and current will increase to the preset parameters. The preset current may be limited by the charge/discharge capacity and the input voltage setup. The maximum charging process can operate with 400W. The max discharging process can operate with 60W.

Tapping the graph will access the data view page. The operating data can be displayed. Please refer to pages 27–29 for further information.

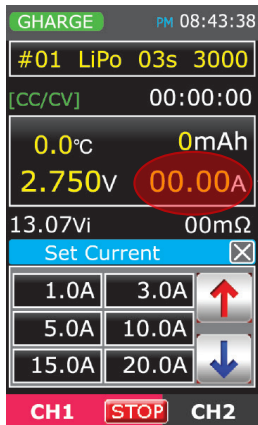

Tapping the part in the red circle (image to the left), the set current window will appear. The operating charge current can then be set. Tapping the X button will cause the set current window to disappear. This setup is applied to the charger during the charging process and the parameters are not stored in the memory.

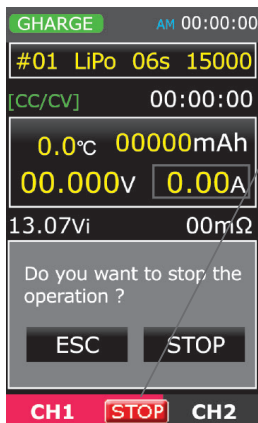

Pressing the STOP button will cause a pop-up window to appear, asking whether to stop operating. Tapping the STOP or ESC buttons will cause the charger to either stop or continue with the charging process, respectively.

DISCHARGE PAGE

Tapping the DISCHARGE icon on the main page will access the discharge mode. The programming setup and the page transition are the same as described for the CHARGE mode.

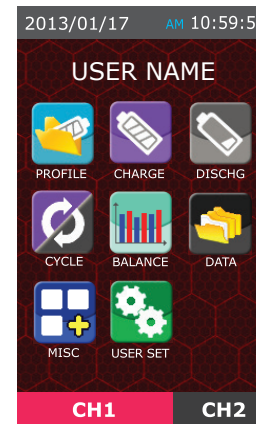

On the main page, tap the DISCHARGE icon to start the discharge process.

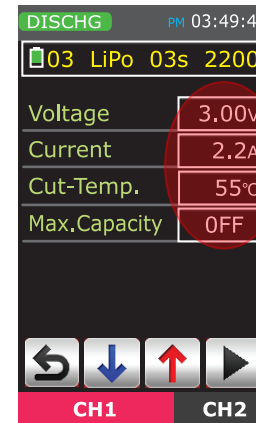

This page shows discharge setup for selecting LiPo, Lilon, LiFe, NiCd, NiMH, Pb batteries

Tapping the part in the red circle (image on the left) will activate the parameters (blue), allowing the values to be programmed into the data spots.

• LiPo, Lilon, LiFe, NiCd, NiMH, Pb battery discharge modes

- Voltage : Final discharge voltage for each cell can be programmed
- Current : Discharge current. – This parameter can be adjusted from 0.1 to 10 Amps, operating within the maximum value of 60W.
- Cut-Temp : Cut-off temperature. – With an optional temperature sensor, a safety cut-off temperature can be set, allowing the charging or discharging process to terminate automatically for battery temperatures exceeding the preset temperature.
- Max Capacity : The maximum capacity setting is used to terminate a discharge at battery capacities exceeding a preset percentage value. Damaged, poorly balanced or improperly programmed battery parameters can result in an overdischarge.

The programmed data are stored to memory to be used in the battery discharge process. Tapping the Enter button causes the charger to initiate the preliminary steps, including a check of the balance connector, discharge mode, number of cells, and the delay time setup. The discharge process starts immediately after these preliminary steps. With proper programming, the charger will display a 5-second countdown. The discharging sequence is shown below.

• LiPo, Lilon, LiFe, NiCd, NiMH battery discharge processes

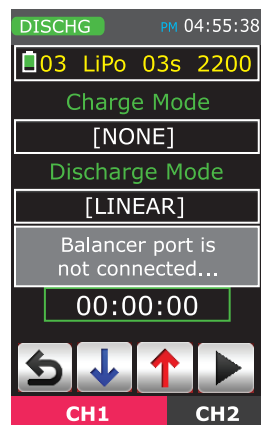

The charger checks for a connection with the balance board. This process is automatic.

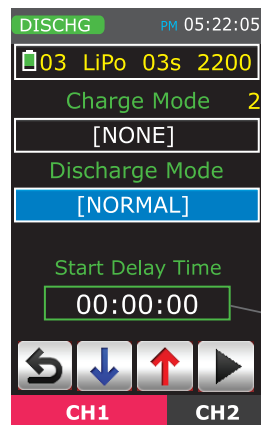

Discharge mode selection

The discharge mode and the delay time are programmed. Tap the box to activate (blue). Tap the DEC/INC button to select the desired mode. The discharge modes are explained below. After counting down, the charger initiates the discharge process. Tapping the Enter button  will cause the charger to immediately initiate the discharge process.

Delay time setup

The delay time can be programmed to values between 1–150 minutes. After this preset time, the charger will then initiate the battery discharge process.

• Discharge mode per battery type

[AUTOMATIC]

- In this discharge mode, the discharge process proceeds automatically. The first two steps include checking the number of cells and determining the discharge current. The charger then calculates the internal resistance and discharge current for every period of time. The programming automatically adjusts the discharge current to ensure that the optimal discharge current is delivered to your pack.
- Cutoff voltages (NiCd=0.9V/cell, NiMH=0.8V/cell, Lilon/Po=3.0V/cell, LiFe=2.5V/cell, Pb=1.8V/cell) are applied (Charging the Lithium and Pb batteries after discharging does not affect the battery performances.)
- The preset CUT-TEMP is used in this discharge mode.

[NORMAL]

- The charger will stop the discharging process every minute to calculate the average resistance.

[LINEAR]

- The charger will discharge the pack, stopping once after 3 minutes to calculate the internal resistance.



Discharge mode for the POLARON EX CHARGER	
LiPo, Lilon, LiFe	NORMAL : Normal discharge. LINEAR : The preset current is maintained throughout the discharge process. LINK : The packs with the same number of cells and capacity can be discharged simultaneously.
NiCd, NiMH, Pb	AUTO : The charger will automatically adjust the discharging conditions. NORMAL : Normal discharge process. LINEAR : The preset current is maintained throughout the discharge process.

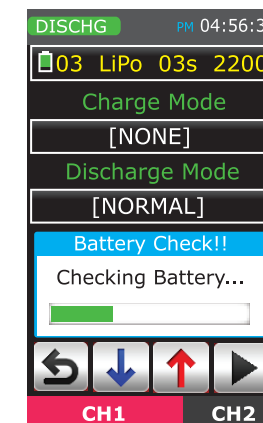

In the LINK mode, the packs should have the same voltage, capacity and number of cells. Differences in these charging parameters can cause damage to the batteries.

* Please install the balance cable to CH1, CH2.



→ This page (left) shows the battery check process with the balancer connected to the charger. Tapping the Enter button  will access the next page and cause the charger  to automatically initiate the charge process.

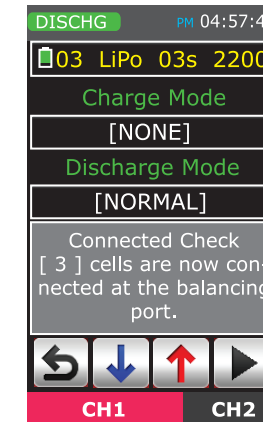

Number of cells checking

After connecting the balance board, the charger can then check the number of cells. If the number of cells is incorrect, tap the ESC button to return to the previous page and re-check the parameters. With the correct number of cells, the next page will automatically be accessed. To initiate without a balance board, the number of cells should be determined and manually entered. After tapping the Enter button, the charger will then immediately initiate the discharge process.

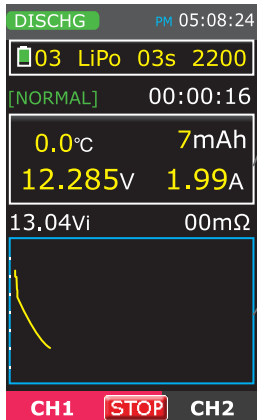

This page (left) shows a display of the discharging process with the parameters and graph. Both the voltage and current will increase to the preset parameters. The preset current value may be limited by the charge/discharge capacity and the input voltage setup. The max charge operates at 400W with the max discharging at 60W.

Tapping the graph will access the data view page, allowing the operating data to be displayed. Please refer to pages 27–29 for more information.

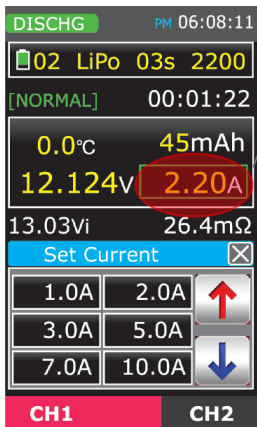

Tapping the part in the red circle (left) will change the screen to the Set current window. The discharge current parameter used during the operation can then be entered. Tapping the X button will return to the operating window. These setup parameters are immediately used by the charger in the discharging process and the parameters are not stored in the memory.

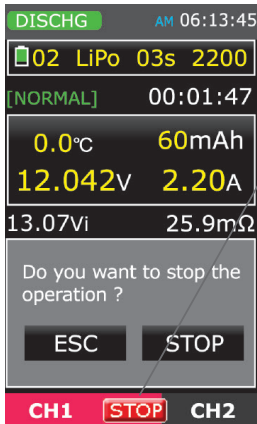

Pressing the STOP button will cause a pop-up window to appear, asking if you want to stop operating. Tapping the STOP or ESC buttons will cause the charger to either stop or continue the discharge process, respectively.

© CYCLE PAGE

Tapping the CYCLE icon on the main page will access the cycle mode. Tapping the data box will activate this parameter (blue). Tapping the DEC/INC buttons will access the program for the parameters.

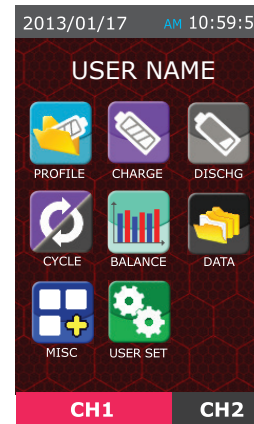

Tap the CYCLE icon on the main page to access the cycle mode.

• LiPo, Lilon, LiFe, NiCd, NiMH, Pb battery cycle pages

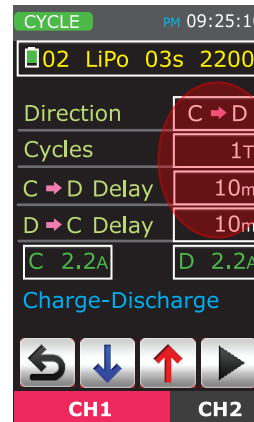

Tapping the part in the red circle will activate (blue) this parameter, allowing this value to be programmed. The parameters entered into the Charge and the Discharge mode are used to set the charge/discharge current during the operations. Tapping the Enter button will access the next page.

- 1) Operating sequence of the cycle mode
 - C > D – Discharge after the charge
 - D > C – Charge after the discharge
 - D:C > D – 1 time discharge: Discharge after the charge
- 2) Cycle – The number of operating cycles (1–10 times)
- 3) C→D Delay – Time interval after the charge (1–30min)
- 4) D→C Delay – Time interval after the discharge (1–30min)



The parameters entered into the Charge and Discharge modes are used in the charge/discharge processes. These values can be changed.

• LiPo, Lilon, LiFe, NiCd, NiMH, Pb battery cycle processes

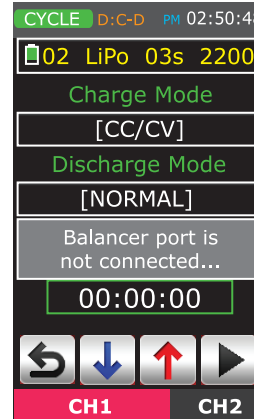

The charger determines if there is a connection to the balancer board. This determination is an automatic process.

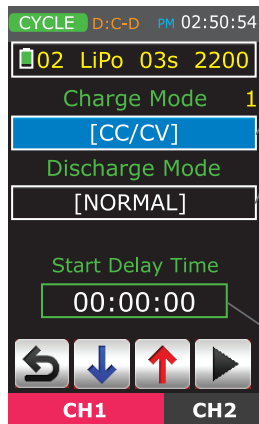

Charge mode selection in cycle mode

Discharge mode selection in cycle mode

The charge mode and the start delay time parameters are programmed. Tap the box to activate (blue). Tap the DEC/INC button to select the desired mode. Discharge modes are explained below

After counting down, the charger initiates the discharge process. Tapping the Enter button  will cause the charger to immediately initiate the charging process.

Start delay time

The start delay time can be set at values between 1–150 minutes. After the preset delay time has completed, the charger initiates the cycle charge/discharge.

• Cycle operation mode per battery type

Cycle charge discharge mode of the POLARON EX Charger		
LiPo, Lilon, LiFe, Pb	CC-CV	: Normal charge mode
	NORMAL	: Normal discharge mode
	LINEAR	: The preset current is maintained throughout the discharge process.
NiCd, NiMH	AUTO	: The charge will automatically adjust the charge/discharge conditions
	NORMAL	: Normal charge/discharge
	LINEAR	: The preset current is maintained throughout the charge/discharge process.

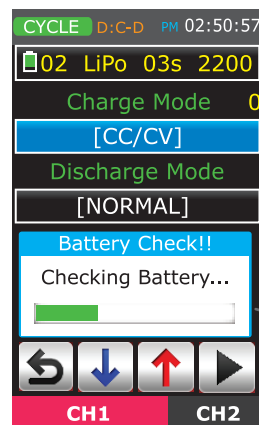

This page (left) shows the battery check process after a connection to the balancer has been established. The next page is accessed automatically. Tapping the Enter button  will cause the charger to immediately initiate the charging process.

Battery Cell Checking

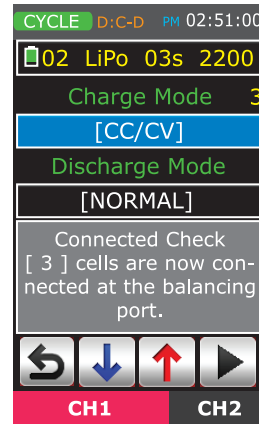

Number of cells checking

After connecting the balance board, the charger can check the number of cells. If the confirmed number of cells is not correct, tap the ESC button to return to the previous page. Re-check the parameters. With the correct number of cells, the next page will be accessed automatically.

To initiate the process without a balance board, the cell can be activated and the number of cells programmed into the cell. Tapping the Enter button  will cause the charger to immediately initiate the charging process.

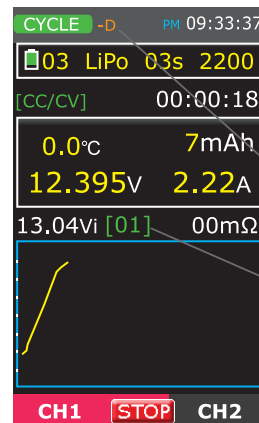

This page (left) shows the cycle process with the parameters and graph. Both the voltage and current values will increase to the preset parameters. The preset current may be limited by the charge/discharge capacity and the input voltage setup. The max charging process operates at 400W with a max discharging process at 60W.

Cycle operating screen
The operating indicator blinks at the top

The number of operating cycles is shown

Tap the graph to display the operating data

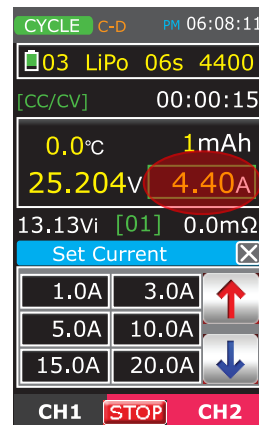

Tap the part in the red circle (left) to display the set current window. The charge/discharge current parameters used during the operations can then be entered. Tap the X button to close the set current window. These parameters are used by the charger during the operation and are not stored in the memory.

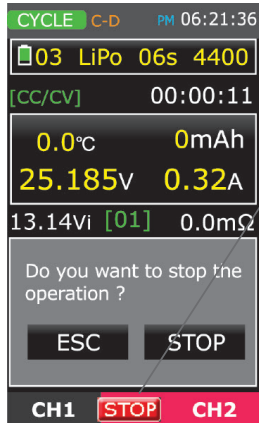

Pressing the STOP button will cause the pop-up window to appear, asking for a confirmation that you want to stop the operation. Tapping either the STOP or ESC button will cause the charger to either stop or continue the cycle, respectively.

◎ BALANCE PAGE

Tapping the BALANCE icon on the main page will access the balance mode. Tap the DEC/INC Buttons to toggle between the 3 modes. Tap the Enter button to initiate the balancing process. The selected mode is used with the batteries that are equipped with a cell balance connector (LiPo, Lilon, LiFe batteries).

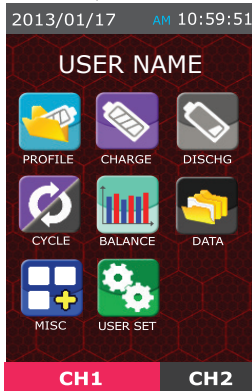

Tap the BALANCE icon to access the balance mode.
(The balance connector should be installed.)

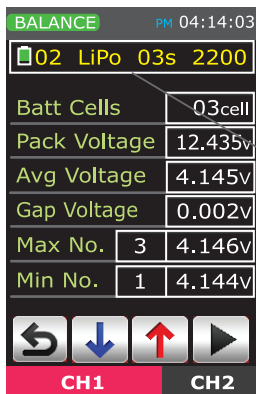

• LiPo, Lilon, LiFe battery balance page
This page (left) displays the connected battery parameters.

Tapping will activate the box (blue). The battery memory can then be selected.

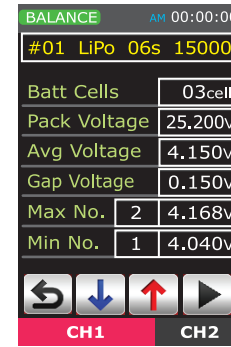

▲ BALANCE MODE 1

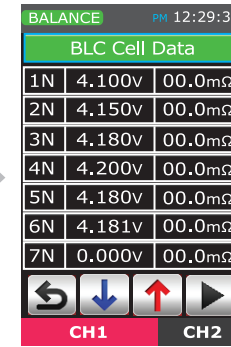

▲ BALANCE MODE 2

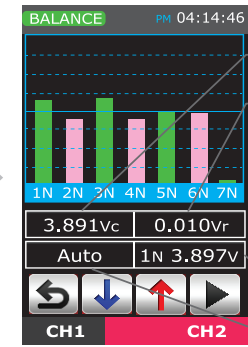

▲ BALANCE MODE 3



- 1) BALANCE MODE 1 : This page (above, left) shows the basic date of the battery.
- 2) BALANCE MODE 2 : This page (above, center) shows the cell voltage and internal impedance values.
- 3) BALANCE MODE 3 : This page (above, right) displays multiple parameters.
 - Center Voltage(Vc): The voltage of the center in the Y axis,
 - Range Voltage(Vr) : The voltage range of every section in the Y axis
 - Manual / Auto
 - Manual: The graph can be manually operated, Tap the data box to activate, Tap the DEC/INC buttons to program the parameters. The Center Voltage and Range Voltage can be activated and programmed using the manual setup.
 - Auto: This mode performs an automatic setup of the graph for the operation. Each cell voltage is activated and checked.
 - Cell Voltage : Displays the cell voltage. Tapping activates this parameter, allowing the cell data to be checked.

◎ DATA VIEW PAGE

Tap the DATA icon on the main page to access the data view mode. There are 3 view modes. After activating the buttons, the data can be programmed by tapping the DEC/INC buttons. In the Cycle data and Graph data modes, the data can be accessed. In the Normal data mode, the parameters can not be programmed.

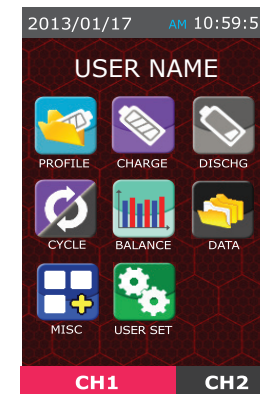

Tap the DATA icon to check the charge/discharge data on the main page.

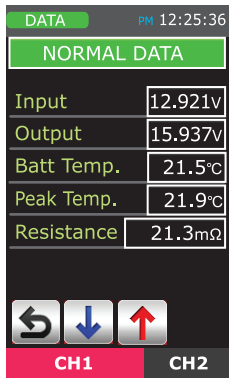

▲ NORMAL DATA

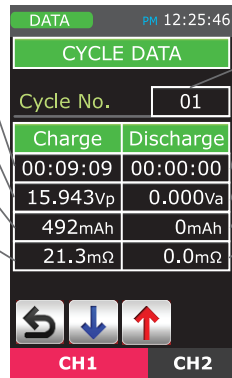

▲ CYCLE DATA

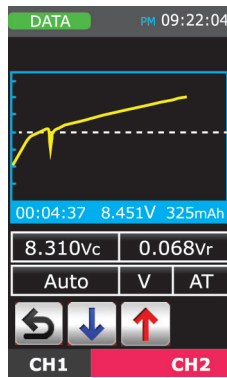

▲ GRAPH DATA

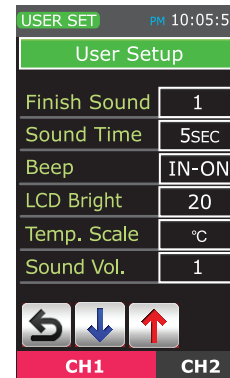

▲ CONFIG MODE 1

Finish Sound : 10 types of sounds are available.
 Sound Time : The times available for the charger are ON, OFF, 5sec, 15sec, and 1min.
 Beep : This parameter can be turned on/off to select either an internal or an external button.
 LCD Bright : Backlight brightness can be adjusted (1-20 steps).
 Temp. Scale : The temperature unit can be changed.
 Sound Vol. : The sound level can be adjusted. (1-5 steps)

- 1) NORMAL DATA : Real time display of the input/output voltage, temperature, resistance of battery.
- 2) CYCLE DATA : Display of the data according to the cycle number.
 - Charge/discharge time: Displays the total time of the charge/discharge process.
 - Peak voltage : Display of the max voltage during the charging process.
 - Charge/discharge capacity: Display of the charge/discharge capacity at completion.
 - Internal impedance of the battery: Display of the internal impedance during charging/discharging.
- 3) GRAPH DATA : Display of the graph with the operating voltage, current, and temperature. The graph reflects the programmed data, entered either automatically or manually.

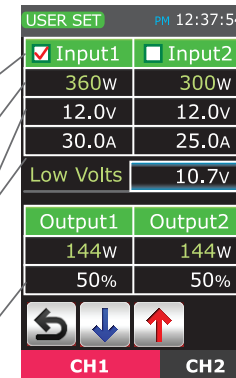

▲ CONFIG MODE 2

- Input of the User's SMSP from the rear side
- The Wattage Setting of the User's SMPS from the rear side
- The Voltage & Current Setting of the User's SMPS from the rear side
- Output Sharing of Ch,1 and Ch,2 (Wattage with percentage)

Input ONLY for Graupner/SJ Side-Docking SMPS (Model No. S2012)
 Low Voltage Error Setting

◎ USER SETUP PAGE

Tap the USER SET icon on the main page to access to user setup modes (4 modes). The data can be programmed. The page can be navigated by tapping the DEC/INC buttons.

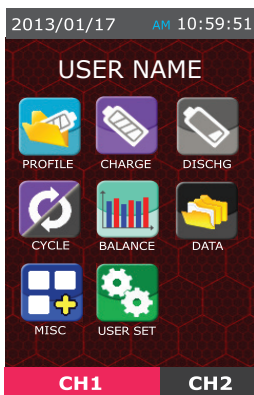

Tap the USER SET icon to program the user setup on the main page.

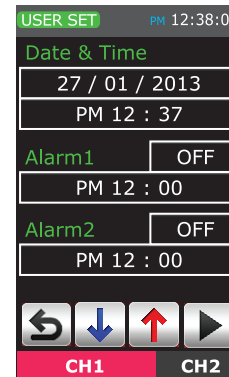

▲ CONFIG MODE 3

Date & Time : Date, month, year, time setup
 Alarm 1 : The first alarm time setup. When not in use, set to OFF
 Alarm 2 : The second alarm time setup. When not in use, set to OFF



CH1 user setup of can be set at CONFIG MODE 1-4.
 Only the Finish sound of CONFIG MODE 1 in CH2 user setup can be set

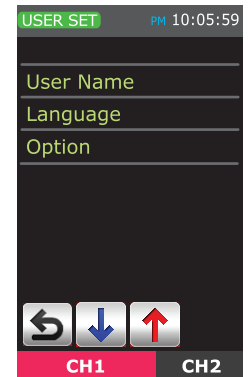

▲ CONFIG MODE 4

User Name : Enter user name
 Language : Not yet applicable
 Option : Not yet applicable

© MISC PAGE (Addition function)

Tap the MISC icon on the main page to access the MISC mode and to program the Servo, Brushless/Brushed power motor, and Warmer functions.

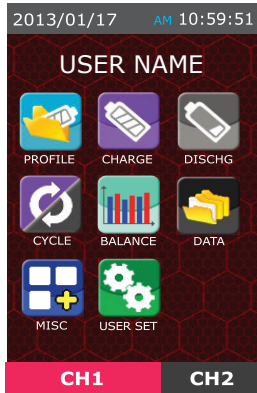

Tap the MISC icon to program the MISC setup on the main page

Additional functions on CH1 or CH2 can also be used.

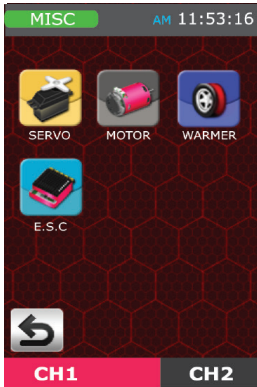

→ This is the MISC setup page.

Tap the 3 icons to access each mode. Tap the ESC button to return to the previous page.



– Used to test the Servo and Brushless Motor.



– Used to test and condition the Brushed Motor.



– Used to warm up the batteries and tires.



– Used for the speed controller setup and settings.



Servo and Brushless motor testing setup

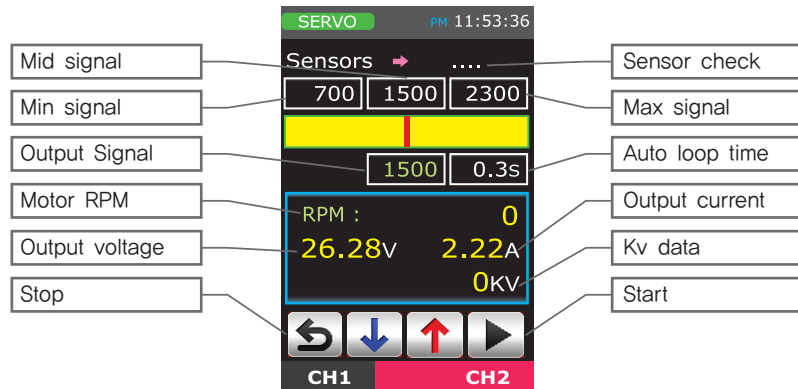

1) Servo test division (Screen top)

- Connect the Servo to the connector on the right side of the charger (see picture, below).

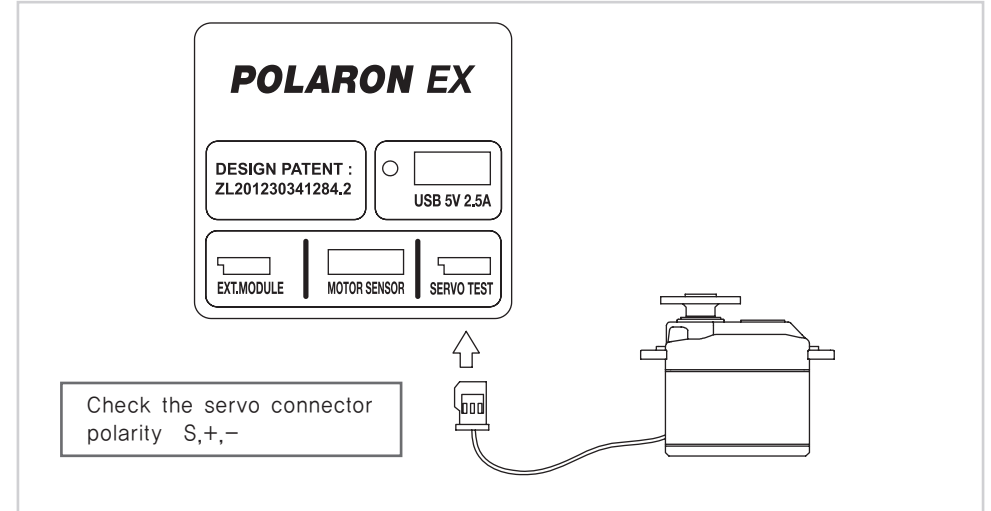

- Min, Mid, Max signal : Tap the relevant buttons, The servo is operated in accordance with the preset signal. The parameters of each article can be changed by tapping the DEC/INC buttons.
- Output signal : Displays the current signal output parameters.
- Auto loop time : After entering the Auto loop time (0,1 – 5,0sec), tap the Enter button. High power servos may not function well using only short operating times, as these servos often require a high peak current demand. For these servos, extend the operating time to accommodate the increased peak current requirements.

2) Motor test division (Screen Top and bottom)

- Motor sensor connector and servo test connector are both used.

- The 3 sensors at the top indicate if the motor is OK or not.
- RPM and Kv are shown at the bottom.

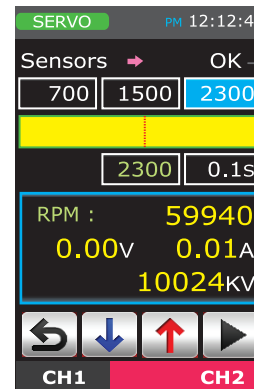

Continuously rotate the motor shaft for approximately 5 seconds. The charger will then indicate if the sensor is OK or not. The motor should be connected to the motor sensor connector.

An (optional) splitter is required to check the motor RPM and Kv. (Please refer to the picture on the next page.)

- The optional accessory

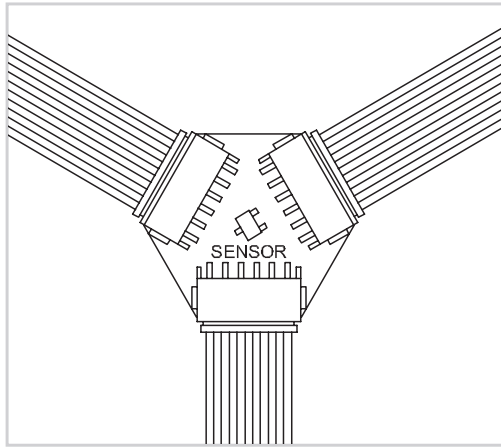

Wire splitter for testing the motor sensor (S8002)

- Connection configuration for the ESC, Motor, Battery, and Wire splitter

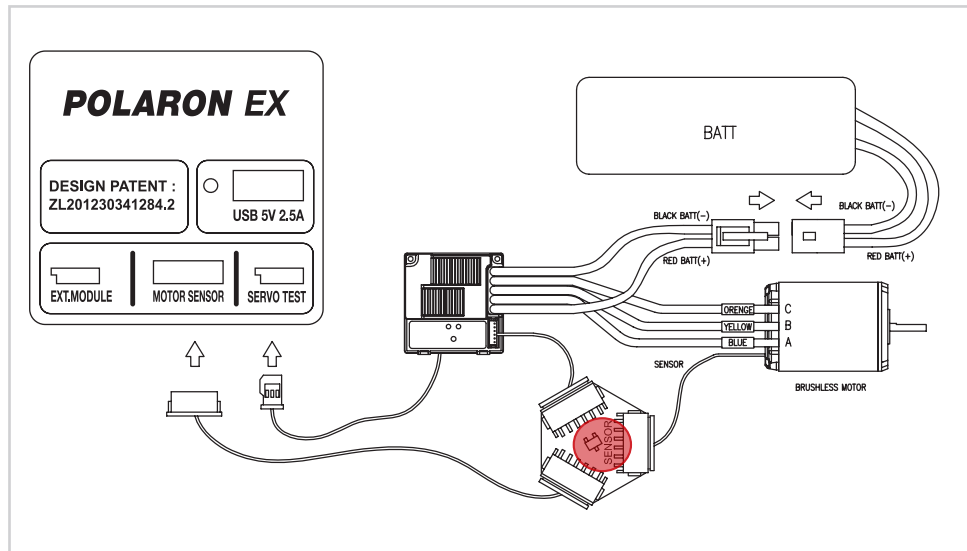

For the connections on the charger side terminal, the connector marked “sensor in the wire splitter” is connected to the motor and the left 2 connectors are connected to the charge and the ESC, respectively. The ESC signal connector is connected to the charge servo test socket.

-  Brushed motor setup

Connect the motor to a 4mm banana charge socket. Tap the MOTOR icon to access the motor setup mode. This page has 3 menus.

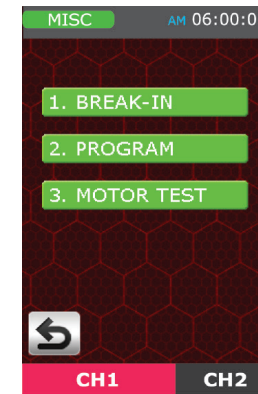
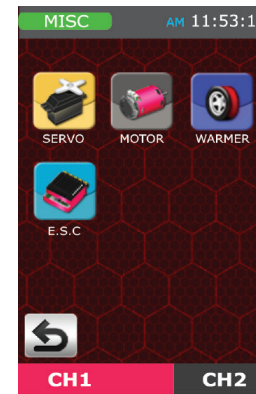

- 1) Break-In
 - The motor is operated and limited by the preset voltage for the preset time.

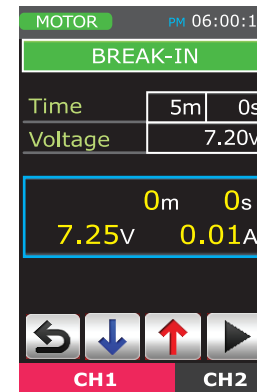

The operating time is set by minutes and seconds

The operating voltage is set.

Tap the Enter button to check the operating time, voltage, and consumption current.

- 2) Program
 - Programming requires 4 inputs: the voltage, the operating time, the delay time and the number of cycles. After entering each data value, tap the Enter button. The charger will repeat to load the motor using the preset number of cycles. The blue character shows the current process.

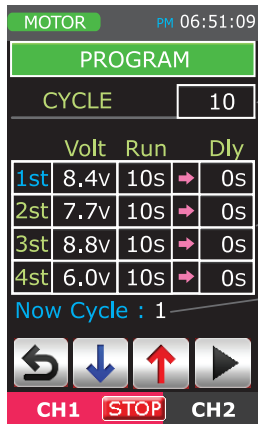

- Setting the number of cycles (1–10 cycles)
- Setting the operating voltage, the operating time, and the delay time, for each of the 4 steps.
- The operating cycle number.

3) Motor test

- For the motor operations (6 steps), the average current (Aa) and the peak current (Ap) can be selected, using either 4.8V or 7.2V.

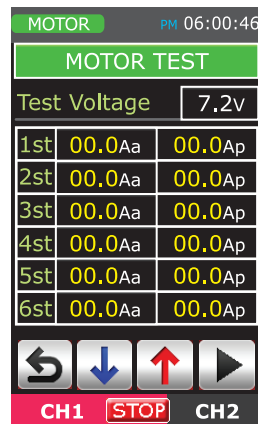

- Test voltage setup, (4.8V or 7.2V)
- Displays the average current and the peak current for 6 steps. Each step is operated using 5sec on/ 3sec off.

• Warmer setup

Connect the warmer to the 4mm banana charge socket. Tap the WARMER icon to access the warmer setup mode. This page has 2 menus.

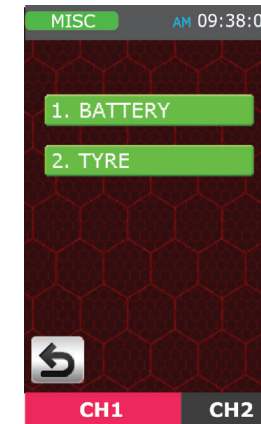
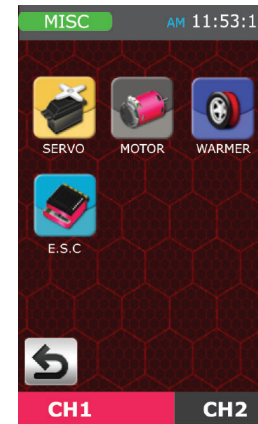

1) Battery Warmer

- At low temperatures, lithium type batteries tend not to perform well. This function is used to warm up the batteries to ensure proper function for batteries stored outdoors. Connect the exclusive battery warmer bag to the charger output terminal and the temperature sensor connector. Then, program the required parameters.

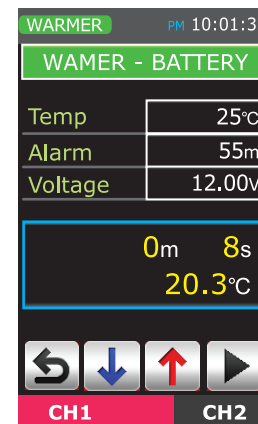

- Temperature setup
- Alarm setup
Alarm rings at the preset time. The charger continue operating. Tap the STOP button to stop the alarm.
- Output voltage setup
With an installed temperature sensor, this function is controlled automatically. The preset voltage can be outputted for operations without a temperature sensor. The temperature setup range is 5–15V
- Processing time and temperature



With bags that can not accommodate a temperature sensor, the temperature can not be controlled automatically. To ensure a proper temperature, control the voltage to maintain the desired temperature inside the bag. Caution is warranted as an over voltage setup can cause fires.

2) Tire Warmer

- This feature can be used to warm rubber tires, providing an important competitive edge on the track. Connect the tire cup to the charger output terminal and to the temperature connector. Then, program the required parameters.

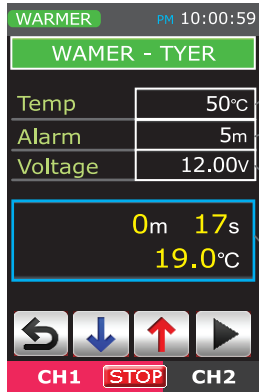

- Temperature setup
- Alarm setup
Alarm rings at the preset time. The charger continues operating. Tap the STOP button to stop the alarm.
- Output voltage setup
With an installed temperature sensor, this feature is controlled automatically. The preset voltage can be outputted for setups without a temperature sensor. The temperature setup range is 5–15V.
- Processing time and temperature



For warmers not equipped with a temperature sensor, the temperature can not be controlled. To warm without a temperature sensor, control the voltage to maintain the desired temperature of the tires. Please notice that an over voltage setup can cause fires.



Speed Controller Setting

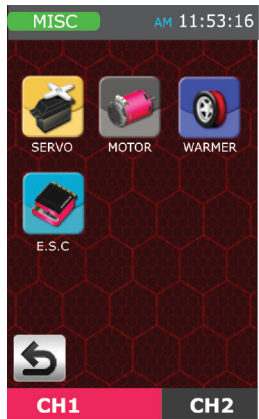

Both the Car ESC and the Air ESC with a telemetry function can be programmed without an extra programmer. Select the ESC setup icon, Turn on the model's power. Then, connect the telemetry terminal to the EXT. MODULE, allowing the data to be displayed and programmed. (pages 38–39)

- The data can be programmed with 6 buttons.
- The 3 modes can be accessed by the DEC/INC buttons.
 - The UP/DW buttons are used for the setup only after the SET button has been touched. Without this toggle, the UP/DW buttons are used to change the page.
 - The ESC setup page can be exited by touching the ESC button.



– CAUTION –

- Depending on the version of the Air ESC, the throttle stick should be in the low-position.
- Depending on the version of the Car ESC, the throttle stick should be at neutral position.
- The ESC setup is not available while other functions are in operation.

- Connection configuration for the ESC setup (Charger, ESC, Motor, Battery, Receiver included)

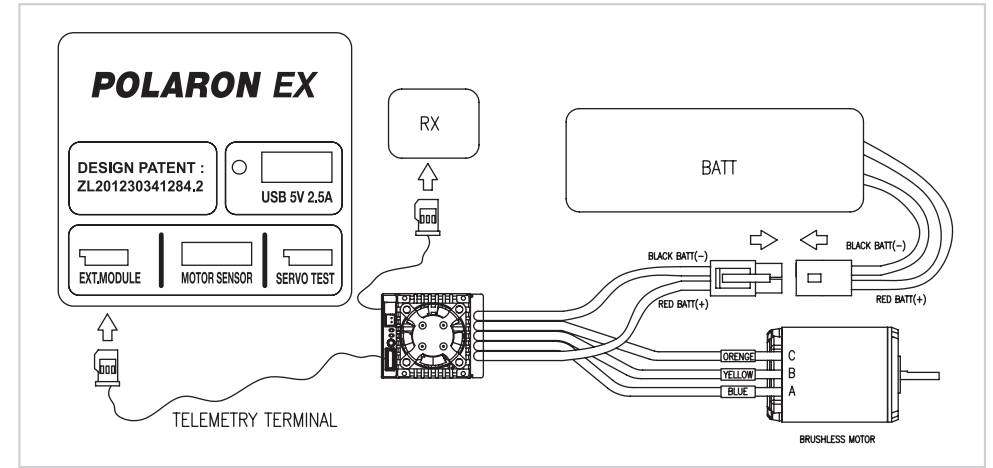

Connect the telemetry terminal to the EXT MODULE. Please note that some ESCs are required to connect the transmitter. Please check the version of your ESC. After connecting a battery to the ESC, the ESC setup will become available. To check the data, connect the telemetry terminal to the EXT MODULE without removing the batteries.

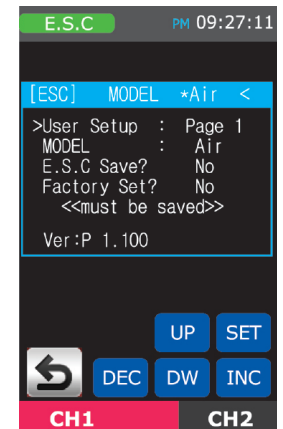
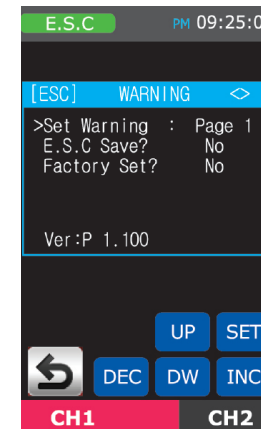
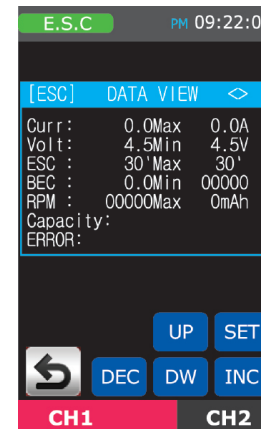

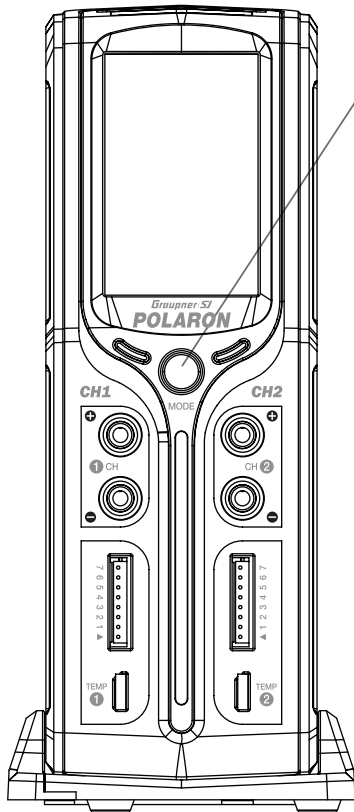

Button for Channel changing and initializing

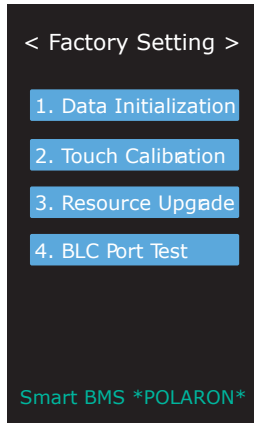

Press and hold the button, Turn on the charger' s power.

1. Return to the factory setup.
2. Touch screen calibration,
3. Image and sound update.
4. Checking the balance port.

The user can adjust No. 1,2,3. The manufacturer can adjust No. 4 (The user can not adjust).

• Data Initialization

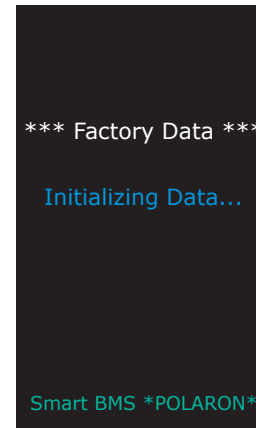

→ Tap No1 to access the factory data mode.
The blinking characters alternate between red and blue, indicating that the program is operational. After the Data Initialization has completed, the return to the Start up page will proceed automatically.

• Touch calibration (Touch screen calibration)

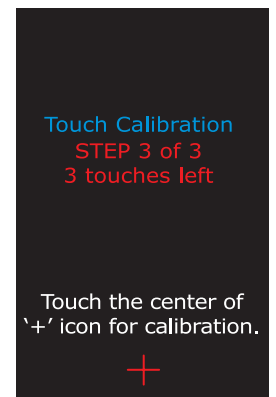
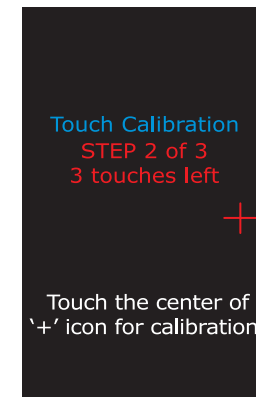
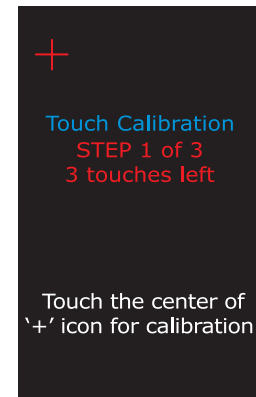

Tap the “+” icon 3 times on the screen to arrange the screen. After completing the arranging process, the system will be rebooted for the charging mode.

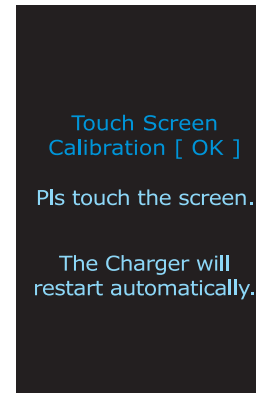

→ Tap anywhere on the screen to complete the Touch calibration. Then, return to the Start up page.

- Resource Upgrade (Image and sound download)



1. This screen is used to download image and sound files from a PC to the flash memory in the charger.
2. Program updates are found at www.openhobby.com and www.graupner-sj.com

- BLC Port Test (Checking balance port)

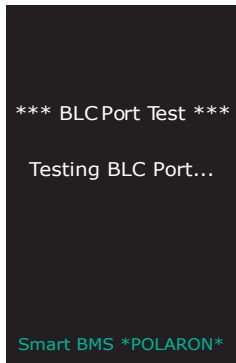

→ This screen (left) is used to check the balance port. Please note that the user cannot access this mode. (Only available to the manufacturer)

© SLAVE BOARD UPGRADE (Product Update)

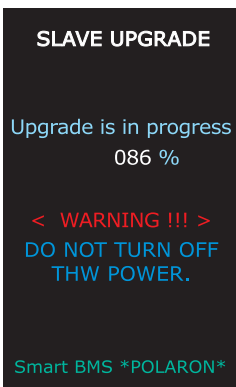

1. This screen (left) is for product updates from a PC (personal computer).
2. Updates are available at www.openhobby.com and www.graupner-sj.com

© ERROR MESSAGES

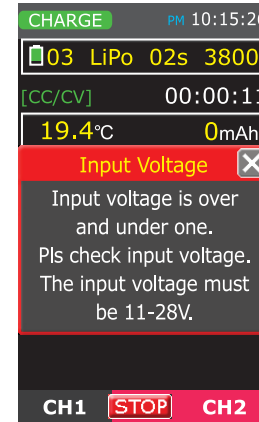

POLARON EX DC chargers have a number of error and warning messages that are designed to advise the user of any problems. Tapping the error message can clear the message and return to the previous page.

- ▶ Input voltages of less than 11V or exceeding 28V.

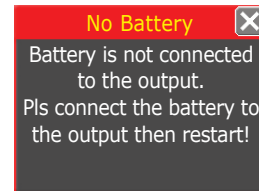

- ◆ A No Battery error message indicates that there is no battery connected to the charger.

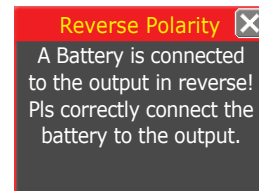

- ◆ A Reverse Polarity error message indicates that the battery is plugged in “backwards”, inverting the positive to negative connections.

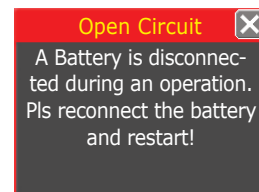

- ◆ An Open Circuit error message indicates that the charging/discharging battery has been disconnected, during an operation.

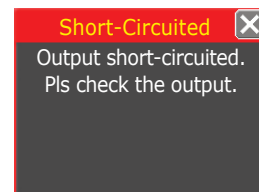

- ◆ A Short-Circuited error message may indicate multiple errors, including faults at the charger output leads, at the battery leads, within the battery and connections on the cables, causing the short circuit.

Low Output-Volt

Output voltage is lower than the selected cells or voltages.
Pls select proper cells or voltages.

High Output-Volt

Output voltage is higher than the selected cells or voltages.
Pls select proper cells or voltages.

Temp. Sensor

A temperature sensor is connected in reverse or is defective.

Bat.Temp Too Low

Battery temp is too low to be operated !

Bat.Temp Too High

Battery temp is too high to be operated !

Internal Temp.

Internal temp is too hot!
Contact Hobby Services if this message appears often.

BLC Volt High

Balancer cell voltage is too high !
Over cell is [0]

◆ A Low Output-Volt error message indicates that either the voltage setup is below the requirements for the charging/discharging battery or the number of cells has been improperly selected.

◆ A High Output-Volt error message indicates that either the out voltage setup exceeds the requirements for the charging/discharging battery or the number of cells has been improperly selected.

◆ A Temp. Sensor error message indicates that the temperature sensor either is plugged in “backwards” with the positive to negative connections inverted or has a fault inside the sensor.

◆ A Bat. Temp Too Low error message indicates that the battery temperature is too low to operate using the charging process.

◆ A Bat. Temp Too High error message indicates that the battery temperature exceeds the preset temperature values.

◆ An Internal Temp. error message indicates that the internal temperature within the charger exceeds the recommended operating conditions.

◆ A BLC Volt High error message indicates that the balancer cell voltage exceeds the recommended operating conditions.

BLC Volt Low

Balancer cell voltage is too low !
Low cell is [0]

Calibration

Either calibration data or internal circuit might have been damaged.

No Sensor

A temp-sensor is not connected to the port.
Pls connect the sensor to the port then restart!

Connection

Selected cells and cells connected to the balancing port are different !
Pls recheck and restart!

Motor Current

Pls reconnect the motor and restart !

Balancer Port

BLC Port is opened.
Pls check the BLC port.

Sync. Command

Sync order failed.
Error occurred in the counterpart channel !

◆ A BLC Volt Low error message indicates that the balancer cell voltage is below the recommended operating conditions.

◆ A Calibration error message indicates that there is a fault in either the default calibration data or the internal circuits of the charger.

◆ A No Sensor error message indicates that the temperature sensor has been disconnected.

◆ A Connection error message indicates that the preset number of cells and the detected number of cells are different.

◆ A Motor Current error message indicates that the operating current exceeds the value in the MISC MOTOR function.

◆ A Balancer Port error message indicates that the balance connector has been disconnected.

◆ A Sync. Command error message indicates that the preset number of cells and the number of cells of CH1, CH2 are not matched to the values entered into the Charge/dischARGE and Sync modes.

© COMMON PROBLEMS AND PRECAUTIONS FOR THE POLARON EX DC CHARGER

- The charger has been turned on, but the LCD Screen is off.
 - Check that the external power source is an appropriate source.
 - This charger should be operated only with the types of power sources that are indicated on the specifications.
 - Please contact the A/S center for additional information.
- The charger does not recognize the batteries.
 - Check that the battery connections and the polarity are correct.
 - Worn or excessively used cables should be replaced.
 - Replace damaged or defective cells in the battery pack.
- Battery voltage is low after the charging process has been completed.
(Cell voltages: NiCd, NiMH less than 1.2V or LiPo, Lilon less than 3.6V or 3.7V)
 - Increase the max charge capacity if the final results are too low.
 - Control Peak sense of NiCd, NiMH, if the values are too low or high
 - Replace worn or damaged charge cables.
- Discharging mode cannot be accessed.
 - Check to see if the the preset battery voltage and the cell voltage match.
 - Change damaged or defective cells in the battery pack.
- The mAh/time is too low after the charging process has completed.
 - The battery may not be fully charged.
 - Fully charge the battery and repeat the discharge process. Perform a cycle process to improve the battery capacity for worn out or infrequently used batteries.
 - Reduce the discharge cut-off voltage values that have been programmed too high. Control the discharge ratio.
 - Check that the preset battery voltage and the cell voltage values match.
 - For discharging with over current, repeat the discharge process to discharge the remaining current. For example: for discharging processes exceeding 5A, cool down the battery and repeat the discharge with 1A.
- Charging Lithium type batteries.
 - Use a balance board with an EH to XH cable (MUST).
 - Do not charge Lithium battery packs above the maximum charge rate. Using excessive charge rates can damage the pack and be dangerous. Generally, Lithium Polymer packs should not be charged above 3C. However, some newer packs do allow charging at up to 5C, but charging at these higher rates will reduce the life of the pack.

© NiCd, NiMH BATTERY SAFETY

- With charging new NiCd/ NiMH batteries for the first time, the process may terminate within minutes. This stoppage does not indicate a problem. This stoppage results from an unstabilized battery. To stabilize the batteries, charge the batteries either after increasing the delta peak value or after performing a discharging process followed by a cooling down period.
Do not use the batteries, if the charged capacity of the battery exceeds the specifications for the battery capacity. If you experience repeated terminations upon charging, repeat the charge and discharge process by at least 5 times and then repeat the charging process. Premature terminations may occur up to the third time that the battery has been charged.

© Pb BATTERY SAFETY

- Pb batteries need to be charged every day. If the charged capacity of the battery falls below 50%, this battery may not be recharged. The average charge time of a Pb battery is 4–5 hours. Do not charge with an automobile battery, as the charger may be seriously damaged.

© Lilon, LiPo, LiFe BATTERY SAFETY

- Only charge batteries that have a Lithium ion or Lithium polymer mark.
- Do not charge batteries that have a Lithium mark. Charging Lithium mark batteries will damage the batteries and may cause fires or personal injuries.
- Only charge batteries labelled with these cell voltages (3.3V / 3.6V / 3.7V).
- Place the charger and battery on a non-flammable surface during the charging process.
- NEVER charge Lithium ion/Polymer/Fe batteries inside a vehicle.
- Always ensure that the charger is correctly programmed for the battery being charged, checking both the voltage and the capacity. Be particularly careful with series/parallel battery packs or using packs of different specifications with the same charger.
- Never charge at a rate exceeding the recommended specifications by the cell manufacturer. (VERY DANGEROUS).
- Do not leave Lithium ion/Polymer/Fe batteries unattended during the charging process. Continual monitoring of the batteries is very important.
- Every few minutes, check the temperature of the battery being charged. If the battery becomes hot to the touch, disconnect it from the charger immediately and allow to cool. Do not restart the charging process until both the battery and the charger have been checked for compatibility and the charger settings have been confirmed as being correct.
- In the unlikely event of the Lithium ion/Polymer/Fe battery catching fire, DO NOT use water to attempt to put the fire out! Instead, use sand or a fire extinguisher designed for electrical fires.

- When used correctly, Lithium ion/Polymer/Fe battery packs are as safe as any other type of rechargeable battery pack. However, these batteries do require different charge regimes than the more established Nickel Cadmium and Nickel Metal Hydride technologies and have the potential for catching fire, if severely mistreated.
- If Lithium Polymer battery packs are short-circuited or severely over-charged, elemental Lithium may be deposited internally. If the battery pouch is damaged, elemental Lithium can escape from inside the battery. If this occurs, a fire may result. Elemental Lithium is highly reactive with exposure to water or moisture, producing flammable hydrogen gas and corrosive fumes. Elemental Lithium is only produced with severely mistreated battery packs. During normal usage, explosions or fires are extremely rare.
- Lithium Ion/Polymer battery packs must NEVER be discharged below 3 volts per cell (Li-Fe 2,0V), as this will result in damage to the cells. If the voltage is allowed to drop below 3 volts per cell, the battery voltage may seem to recover following a charge, but the battery may not have full nominal capacity and a reduction in performance is likely. Allowing the voltage to fall below 3 volts per cell will invalidate all warranty claims.
- Never charge Lithium Polymer battery packs to values exceeding 4,2V per cell, Lithium Ion batteries exceeding 4,1V volts per cell or LiFe batteries exceeding 3,7V per cell. Exceeding these recommended values can cause irreversible damage to the cells and will invalidate all warranty claims.
- Never charge Lithium battery packs at rates exceeding the maximum charge rate, as damage to the pack can occur and this process may be very dangerous. Generally, Lithium Polymer packs should not be charged above 2C (2 x Capacity).
However, some newer packs do allow charging at rates up to 5C. Charging at these excessively high rates will reduce the life of the pack. (e.g Pack of 2500mAh capacity : 2C = 5000mAh = 5A max)
- Do not use discharge rates in excess of those specified with the battery pack, as a significant drop in voltage under load will occur that can dramatically reduce the number of charge/discharge cycles that the battery pack will hold.
- Disposal of the Lithium battery packs requires that the pack be completely discharged. Use a light bulb, electric motor or similar to completely discharge the pack.



Do not allow a Lithium battery pack to short-circuit! A short-circuit may result in a minor explosion with a consequential fire.

- Before charging Lithium battery packs, inspect closely for any damage, such as punctures in the sleeving or swelling (expanding) of the battery. Do not charge if any damage has been detected, even if the battery otherwise appears to be new and unused.
- Before starting the charging process, double-check the settings on the charger to ensure that the correct parameters have been entered for the specific battery pack that is to be charged. Using the wrong settings is likely to result in damage to the battery pack being charged and could result in the battery catching fire.

© The Guide for the related Countries' Certifications

(1) KC Information



Product: POLARON EX CHARGER
Registration Number : MISP-REM-sjr-POLARONEX

(2) Conformite Europeenne



NO. BCT13CC-0279E

Model: POLARON EX DC Battery Charger
Item Number(s): S2011

The object of declaration described above is in conformity with the requirements of the specifications listed below, and accordance with the following applicable directives: 2004/108/EC Electromagnetic Compatibility

EN55014-1:2006+A1:2011
EN55014-2:1997+A2:2008

© ENVIRONMENTAL PROTECTION NOTES

This product must not be disposed of with other waste. Instead, it is the user's responsibility to their waste equipment by handing it over to a designated collection point for the recycling of waste electrical and electronic equipment. The separate collection and recycling of your waste equipment at the time of disposal will help to conserve natural resources and ensure that it is recycled in a manner that protects human health and the environment. For more information about where you can drop off your waste equipment for recycling, please contact your local city office, your household waste disposal service or where you purchased the produce



www.graupner-sj.com
www.openhobby.com