

INSTRUCTION MANUAL

1/10 Scale 4WD RC Nitro & Electric Powered Car

DT5 N1/N2



RH1008 - N1 (Single Speed)

RH1009 - N2 (Two Speed)

DT5 EBD/EBL



RH1018 - EBD (Brushed)

RH1019 - EBL (Brushless)

B O M

TYPE	ICON	SPEC	QTY
Round Head Self Tapping Hex Screw		2#6	4
Button Head Hex Screw		M3#6	4
Cap Head Hex Screw		M3#15	2
		M3#28	5
Flat Head Hex		M3#10	1
Set Screw		M4#4	1
Washer		ø6x3, 1#0.2	1
Nylon Lock Nut		M3	5
O'Ring		Ø31* Ø2	1
Ball Bearing		ø10xø5x4	2

Engine Assembly

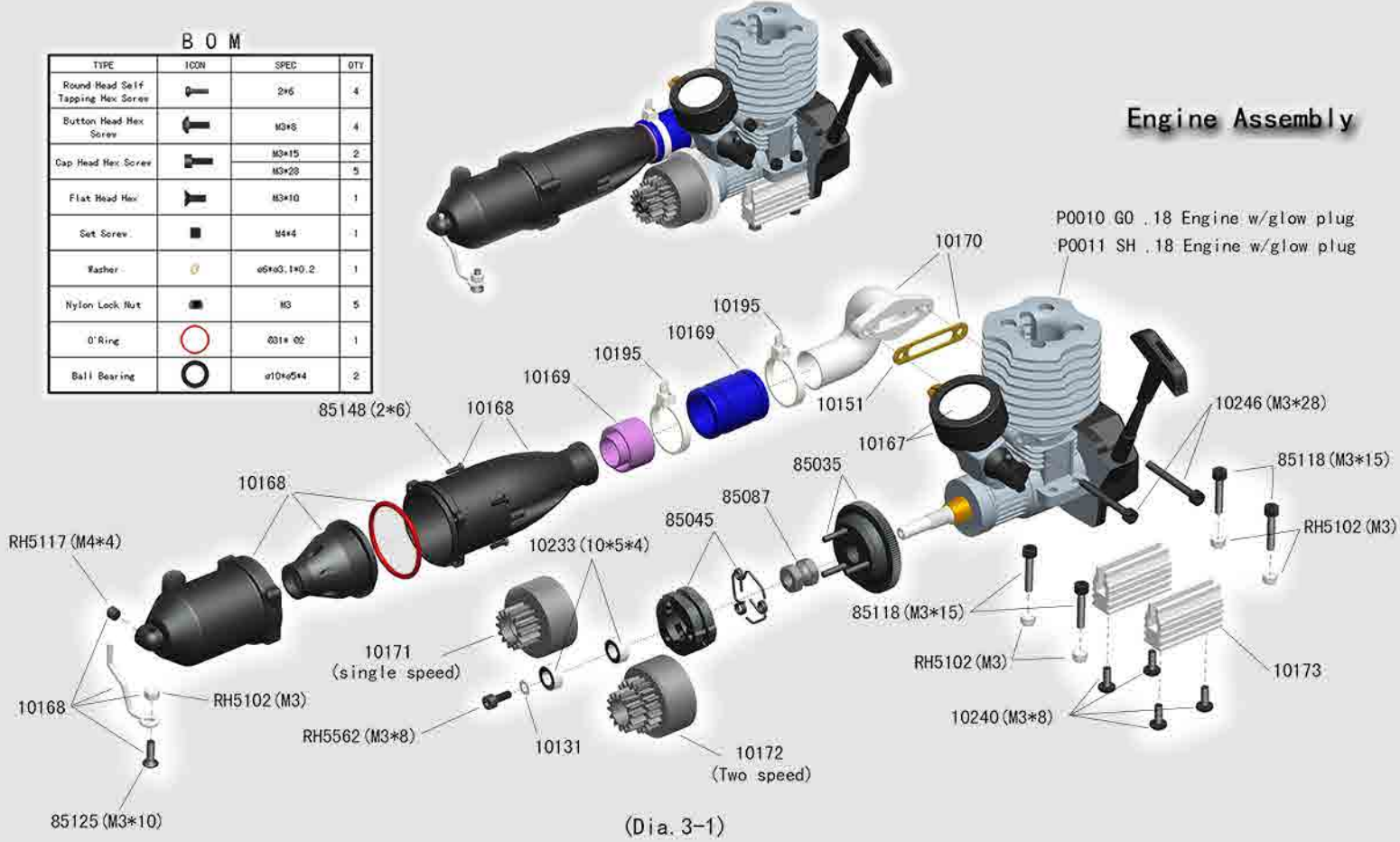

DT N1 Central Trammssion

B O M

TYPE	ICON	SPEC	QTY
Cap Head Hex Screw		M3#10	2
Flat Head Hex		M3#8	4
		M3#20	2
Set Screw		M3#3	1
		M4#4	2
E clip		ø4	3
Ball Bearing		ø10xø5x4	2

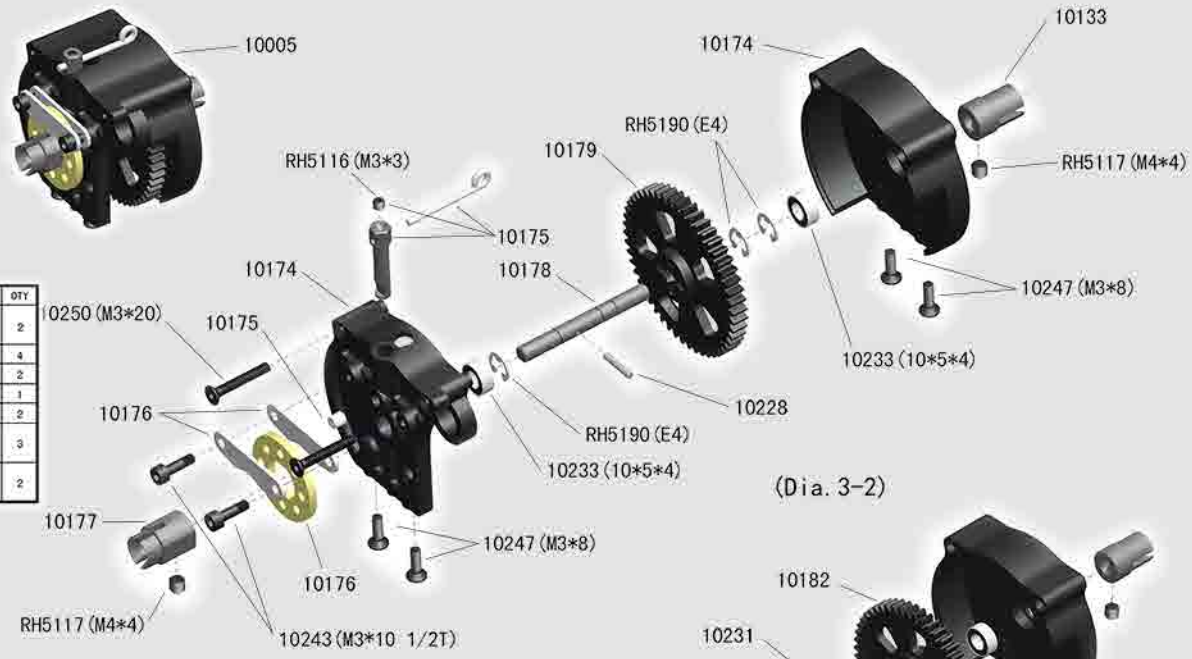

DT N2 Central Trammssion

B O M

TYPE	ICON	SPEC	QTY
Cap Head Hex Screw		M3#10	2
Flat Head Hex		M3#8	4
		M3#20	2
Set Screw		M3#3	1
		M4#4	4
E clip		ø4	1
One Way Bearing		ø12xø6.3x5.4	1
Ball Bearing		ø10xø5x4	3

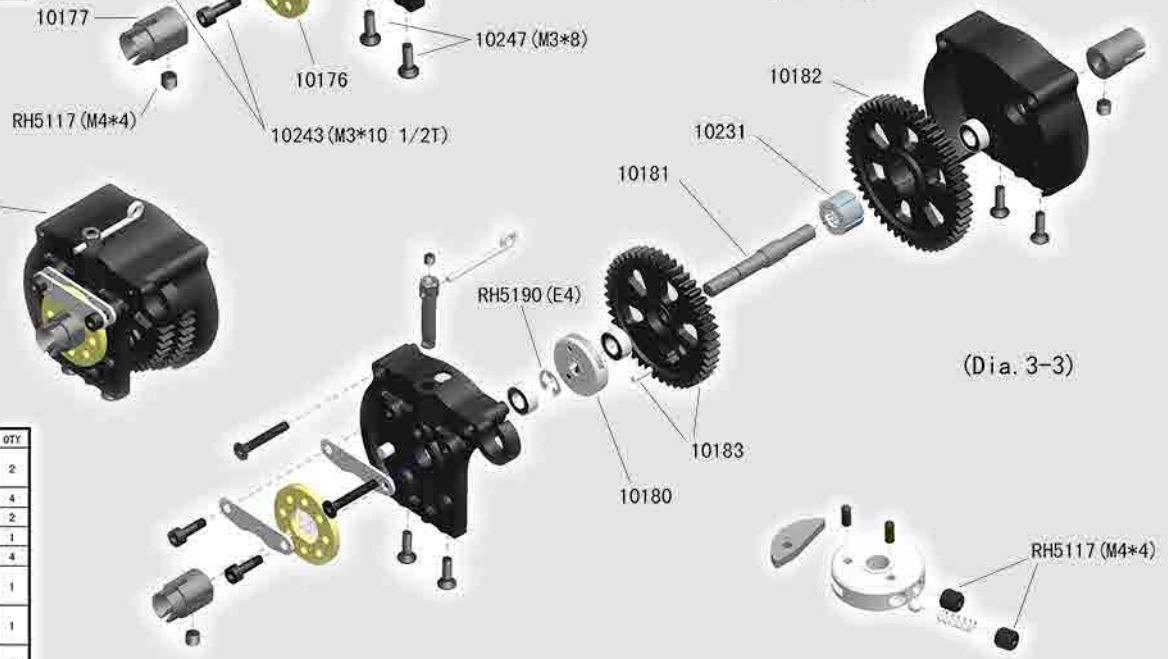

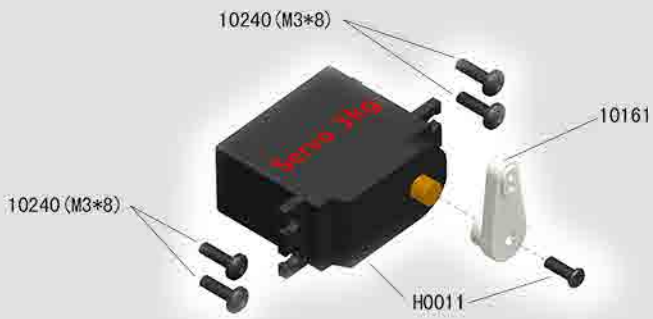

Steering Servo



(Dia. 4-1)



Throttle Linkage



(Dia. 4-2)

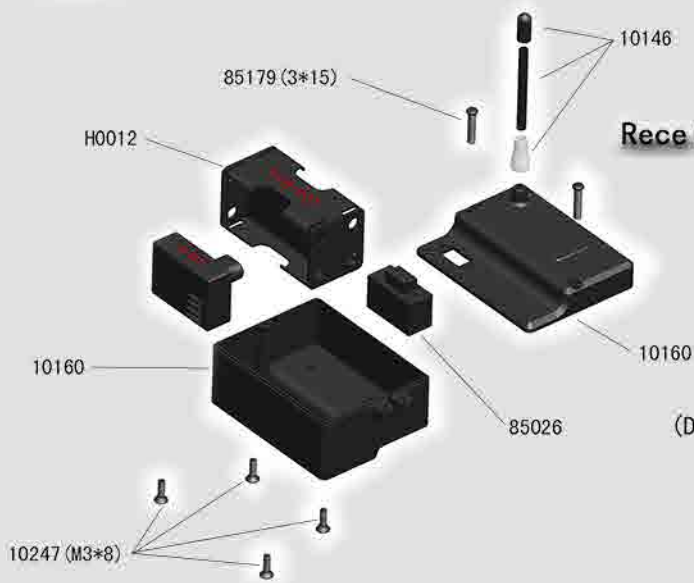

Receiver Assembly



(Dia. 4-3)



(Dia. 4-2)

Fuel Tank



(Dia. 4-6)

Right Wheels



(Dia. 4-4)

Left Wheels

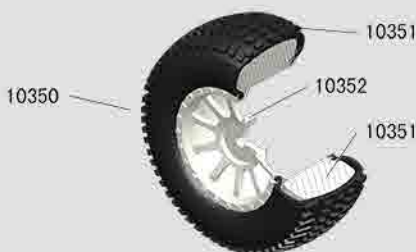

(Dia. 4-5)

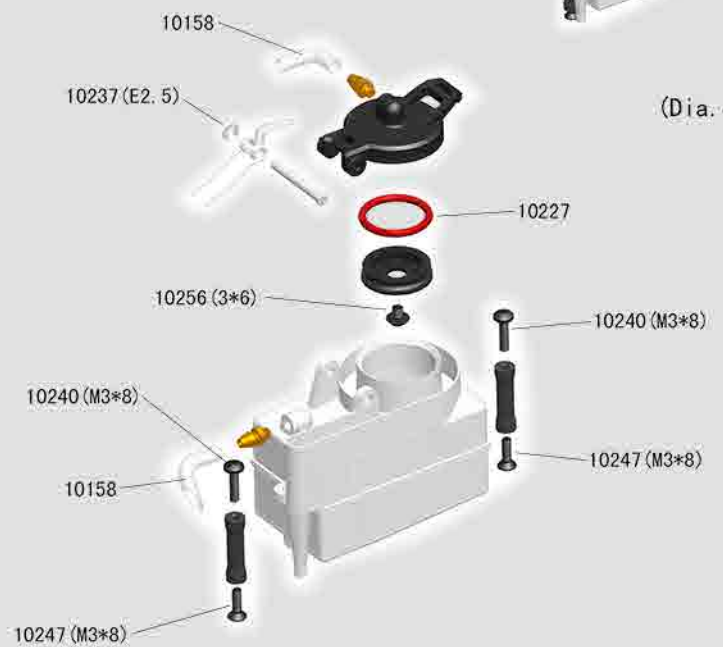

Assembly Steps:

1. Fasten the fuel tank posts to the chassis, then the fuel tank assembly. (See Dia. 4-6)

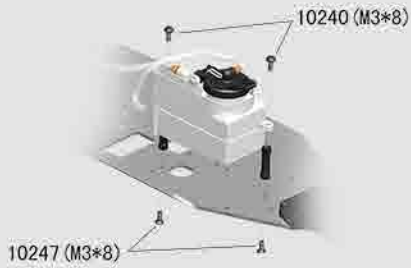

2. Assemble Chassis. (See Dia. 1-3, 4-1, 4-2)

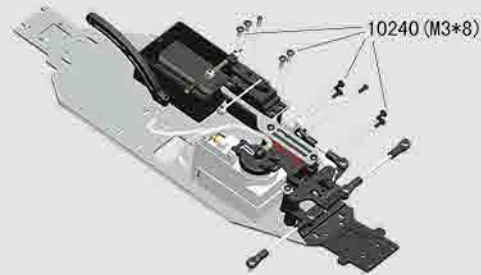

3. Assemble the front assembly to the chassis. (See Dia. 2-1)

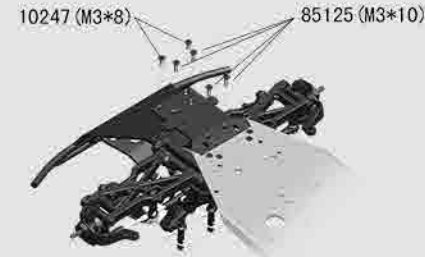

4. Assemble the rear assembly to the chassis. (See Dia. 2-4)



5. Tighten the wheels. (See Dia. 4-4 or 4-5)

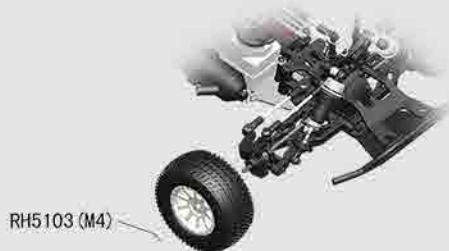

6. Assemble central transmission and rear central drive shaft to the chassis. (See Dia. 3-2 or 3-3)

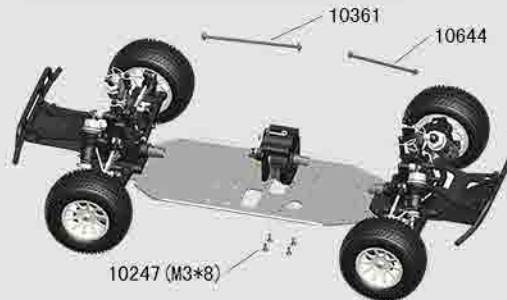

7. Tighten the engine assembly to the chassis. (See Dia. 3-1)

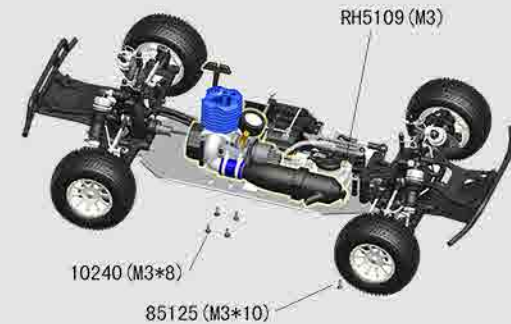

8. Finally connect battery, receiver and setup the electronics functions, then screw the receiver cover and put on the body. (See Dia. 4-3)



Ready To Run !!!



1/10 Scale 4WD Electric Short Course Truck

RH1018 DT5 EBD(Brushed)

RH1019 DT5 EBL(Brushless)

Specifications:

1. Length: 530 mm
2. Width: 290 mm
3. Height: 180 mm
4. Wheelbase: 325 mm
5. Gear Ratio: 8.3:1
6. Tyres: $\Phi 95 \times 40$ mm
7. Weight: 1950 g

HOT!

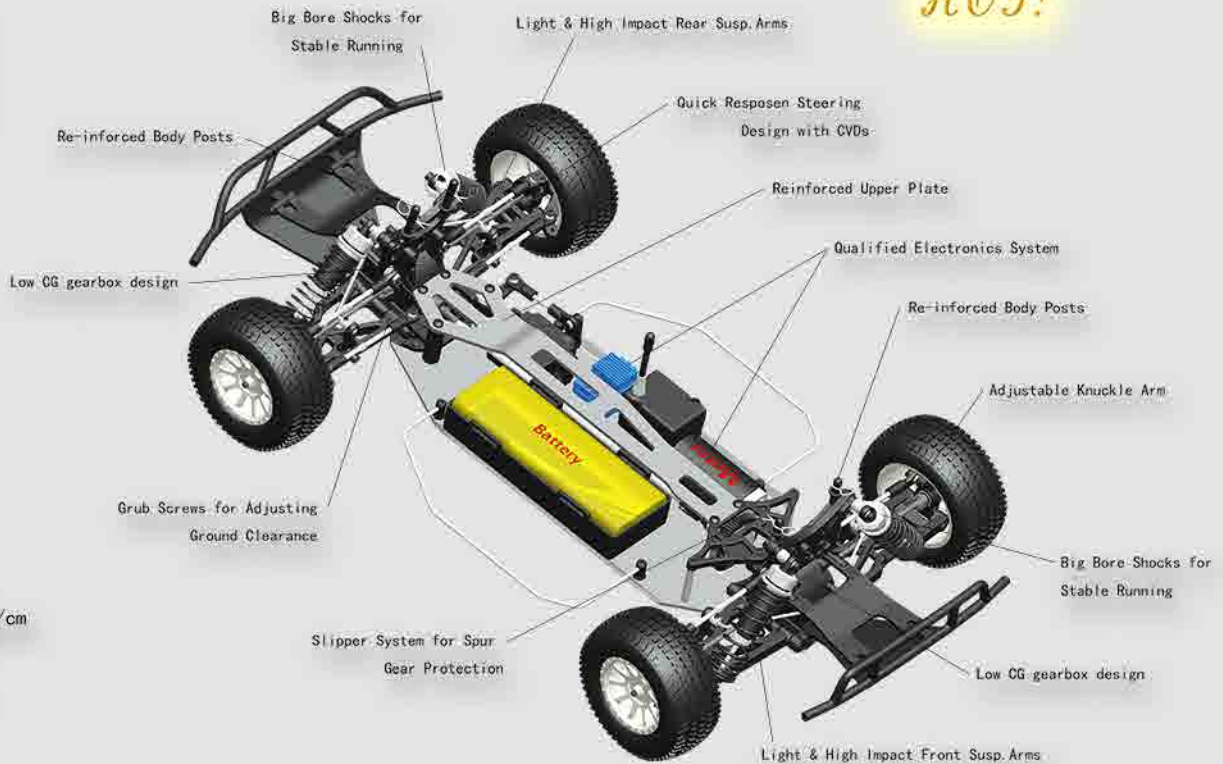

Standard Equipments:

1. Steering Servo: 3kg/cm
2. Motor: 550 (EBD)
3650 (EBL)
3. ESC: 60A (EBD)
300A (EBL)
4. Battery: Ni-MH SC1800mAh 7.2V (EBD)
Li-Po 2700mAh 7.4V $\leq 25C$ (EBL)
5. RADIO: 2CH A M (EBD)
2CH 2.4GHz (EBL)

EBL Brushless System Set:



EBD Brushed System Set:



ASSEMBLY STEPS:

1. Assembly center chassis part.
(See Dia. 6-1)

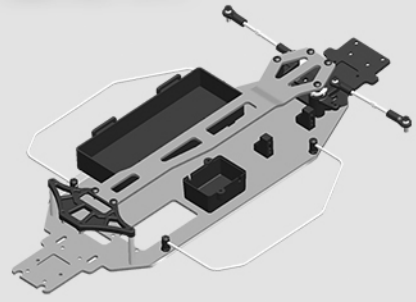

2. Assemble front assembly to chassis front. (See Dia. 2-1)

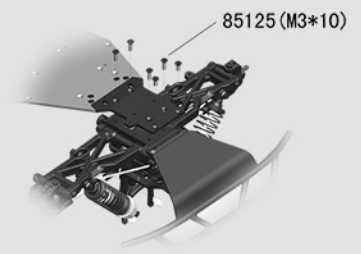

3. Assemble rear assembly to chassis rear part. (See Dia. 2-4)

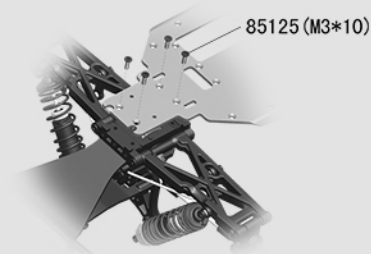

5. Mount the wheels.
(See Dia. 4-4, 4-5)

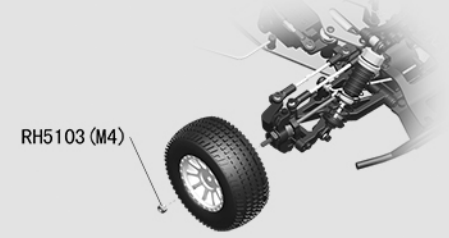

6. Mount the motor assembly and central drive shaft. (See Dia.6-6)

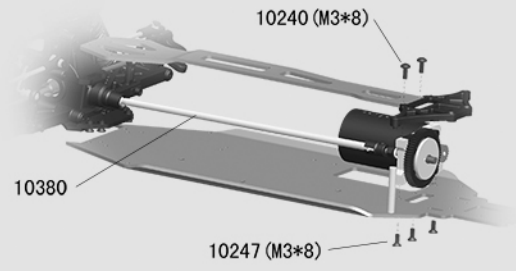

7. Assemble steering servo and linkage. (See Dia.6-4)

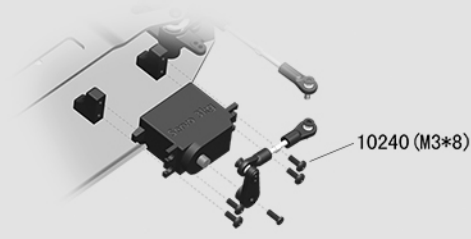

8. Assemble waterproof cover.

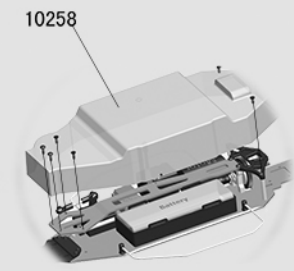

Ready To Run !!!

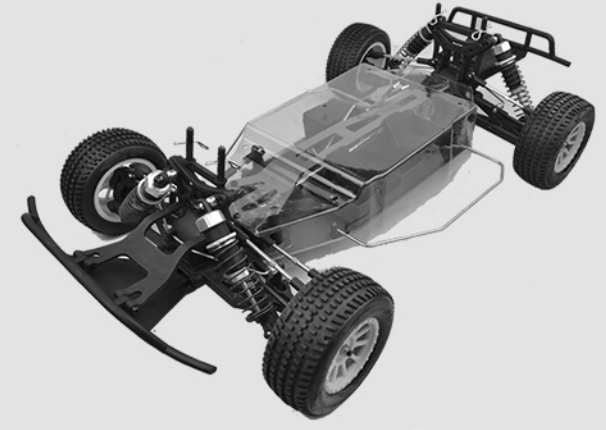

9. Assemble ESC, receiver, battery and connect them to setup. (See Dia. 6-3, 6-5)







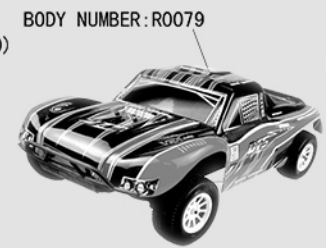
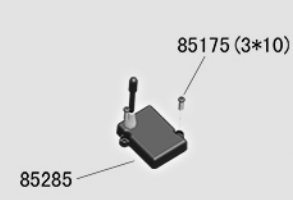







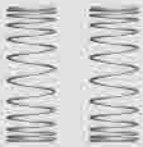
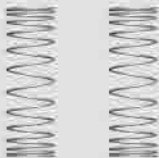

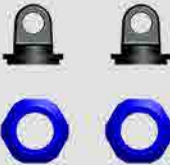

Brushless System:

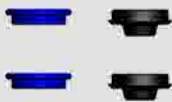
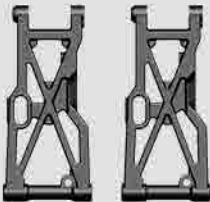
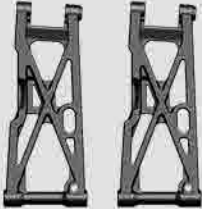





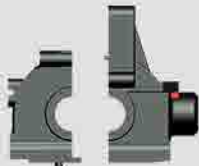





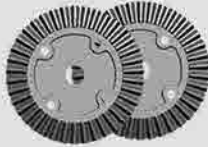











Brushed system:

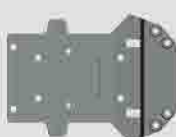

Part List

<p>10101 - Front Shock Tower 1pc</p>  <p>RH1008/RH1009/RH1018/RH1019</p>	<p>10102 -Rear Shock Tower 1pc</p>  <p>RH1008/RH1009/RH1018/RH1019</p>	<p>10001-Front Shocks 2pc</p>  <p>RH1008/RH1009/RH1018/RH1019</p>	<p>10002 - Rear Shock Tower 2pc</p>  <p>RH1008/RH1009/RH1018/RH1019</p>
<p>10103-Front Shock Spring 2pc</p>  <p>RH1008/RH1009/RH1018/RH1019</p>	<p>10104-Rear Shock Spring 2pc</p>  <p>RH1008/RH1009/RH1018/RH1019</p>	<p>10105-Front Shock Shaft & Piston Set 2sets</p>  <p>RH1008/RH1009/RH1018/RH1019</p>	<p>10106-Rear Shock Shaft & Piston Set 2sets</p>  <p>RH1008/RH1009/RH1018/RH1019</p>
<p>10107-Front Shock Body 2pc</p>  <p>RH1008/RH1009/RH1018/RH1019</p>	<p>10108-Rear Shock body 2pc</p>  <p>RH1008/RH1009/RH1018/RH1019</p>	<p>10109-Shock Upper Cap 2sets</p>  <p>RH1008/RH1009/RH1018/RH1019</p>	<p>10110-Shock Lower Caps 2sets</p>  <p>RH1008/RH1009/RH1018/RH1019</p>
<p>10111-Shock Lower holder & Adjust Ring 2sets</p>  <p>RH1008/RH1009/RH1018/RH1019</p>	<p>10112-Front Lower Susp. Arm 2pc</p>  <p>RH1008/RH1009/RH1018/RH1019</p>	<p>10113-Rear Lower Susp. Arm 2pc</p>  <p>RH1008/RH1009/RH1018/RH1019</p>	<p>10114-Steering Knuckle Arm 1set</p>  <p>RH1008/RH1009/RH1018/RH1019</p>
<p>10115-Uprights 2pc</p>  <p>RH1008/RH1009/RH1018/RH1019</p>	<p>10116-Front CVD 2pc</p>  <p>RH1008/RH1009/RH1018/RH1019</p>	<p>10117-Rear Hub Carrier 2pc</p>  <p>RH1008/RH1009/RH1018/RH1019</p>	<p>10118-Rear Drive Shaft 2pc</p>  <p>RH1008/RH1009/RH1018/RH1019</p>
<p>10119-Rear Dogbones 2pc</p>  <p>RH1008/RH1009/RH1018/RH1019</p>	<p>10123-Gearbox Housing Set 2pcs</p>  <p>RH1008/RH1009/RH1018/RH1019</p>	<p>RH5526-Diff 16T Gear Washer 6pcs</p>  <p>RH1008/RH1009/RH1018/RH1019</p>	<p>10124-Diff.Drive Gear w/pin 2sets</p>  <p>RH1008/RH1009/RH1018/RH1019</p>























Part List

<p>10125-Diff Case 2pcs</p>  <p>RH1008/RH1009/RH1018/RH1019</p>	<p>10126-Diff Drive Spur Gear 2pcs</p>  <p>RH1008/RH1009/RH1018/RH1019</p>	<p>10127-Diff Drive Gear 2pcs</p>  <p>RH1008/RH1009/RH1018/RH1019</p>	<p>10128-Diff Bevel Gear S. 4pcs</p>  <p>RH1008/RH1009/RH1018/RH1019</p>
<p>10129-Diff Bevel Gear B. 4pcs</p>  <p>RH1008/RH1009/RH1018/RH1019</p>	<p>10130-Diff Pin 2pcs</p>  <p>RH1008/RH1009/RH1018/RH1019</p>	<p>10131-Washer 6pcs</p>  <p>RH1008/RH1009/RH1018/RH1019</p>	<p>10132-Diff Drive Cup 4pcs</p>  <p>RH1008/RH1009/RH1018/RH1019</p>
<p>10133-Center Coupler 3pcs</p>  <p>RH1008/RH1009/RH1018/RH1019</p>	<p>10379-Body Post 2pcs</p>  <p>RH1008/RH1009/RH1018/RH1019</p>	<p>10135-Servo Saver (GP) 1set</p>  <p>RH1008/RH1009</p>	<p>10136-Servo Saver Post 2pcs</p>  <p>RH1008/RH1009/RH1018/RH1019</p>
<p>10137-Steering Ackerman</p>  <p>RH1008/RH1009/RH1018/RH1019</p>	<p>10141-Front Upper Susp. Arm 2sets</p>  <p>RH1008/RH1009/RH1018/RH1019</p>	<p>10142-Rear Upper Susp. Arm 2sets</p>  <p>RH1008/RH1009/RH1018/RH1019</p>	<p>10143-Steering Arm 2sets</p>  <p>RH1008/RH1009/RH1018/RH1019</p>
<p>10144-Servo Linkage 1pc</p>  <p>RH1008/RH1009/RH1018/RH1019</p>	<p>10145-Wheel Hub 4pcs</p>  <p>RH1008/RH1009/RH1018/RH1019</p>	<p>10146-Antenna Pipe Set 2sets</p>  <p>RH1008/RH1009/RH1018/RH1019</p>	<p>10147-Servo Saver (EP) 1set</p>  <p>RH1018/RH1019</p>
<p>10330-Chassis Front Part 1pc</p>  <p>RH1008/RH1009/RH1018/RH1019</p>	<p>10350-SC truck wheel complete 2sets</p>  <p>RH1008/RH1009/RH1018/RH1019</p>	<p>10351-SC truck tyre & insert 2sets</p>  <p>RH1008/RH1009/RH1018/RH1019</p>	<p>10352-SC truck rim 2pcs</p>  <p>RH1008/RH1009/RH1018/RH1019</p>







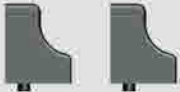



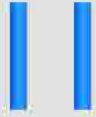

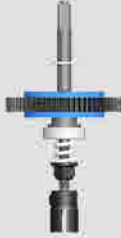

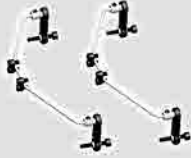

Part List

<p>10362-Front bumper Set 1set</p>  <p>RH1008/RH1009/RH1018/RH1019</p>	<p>10363-Rear bumper Set 1set</p>  <p>RH1008/RH1009/RH1018/RH1019</p>	<p>10003-Diff Gearbox Set 1set</p>  <p>RH1008/RH1009/RH1018/RH1019</p>	
<p>10151-Manifold Gasket 6pc</p>  <p>RH1008/RH1009</p>	<p>10152-Metal Bushing 15*10*4 6pc</p> 	<p>10153-Metal Bushing 8*5*2.5 6pc</p> 	<p>10154-Servo & Upper Plate Mounts 1set</p>  <p>RH1008/RH1009</p>
<p>10156-Upper Plate 1pc</p>  <p>RH1008/RH1009</p>	<p>10157-Upper Steering Plate</p>  <p>RH1008/RH1009</p>	<p>10004-Fuel tank Set 1set</p>  <p>RH1008/RH1009</p>	<p>10158-Fuel Line 2pcs</p>  <p>RH1008/RH1009</p>
<p>10159-Front/Rear Chassis Brace</p>  <p>RH1008/RH1009</p>	<p>10160-Receiver Box 1set</p>  <p>RH1008/RH1009</p>	<p>85026-Switch Cover 2pcs</p>  <p>RH1008/RH1009</p>	<p>10161-Servo Horns</p>  <p>RH1008/RH1009</p>
<p>10162-Chassis Brace mount 1pc</p>  <p>RH1008/RH1009</p>	<p>10163-Stopper 6pcs</p>  <p>RH1008/RH1009</p>	<p>10164-Throttle Linkage 1set</p>  <p>RH1008/RH1009</p>	<p>10644-Central Dongbone F. 1pc</p>  <p>RH1008/RH1009</p>
<p>P0010-GO. 18 engine 1pc P0011-SH. 18 Engine 1pc</p>  <p>RH1008/RH1009</p>	<p>10167-Air filter 1Set</p>  <p>RH1008/RH1009</p>	<p>10168-Tuned Pipe 1Set</p>  <p>RH1008/RH1009</p>	<p>10169-Silicone Coupler 1Set</p>  <p>RH1008/RH1009</p>





















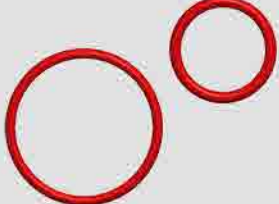

Part List

<p>85195-Zip Tie 6pcs</p>  <p>RH1008/RH1009/RH1018/RH1019</p>	<p>10170-Manifold 1Set</p>  <p>RH1008/RH1009</p>	<p>85035-Flywheel 1pc</p>  <p>RH1008/RH1009</p>	<p>85087-Clutch Nut 2pcs</p>  <p>RH1008/RH1009</p>
<p>85045-Clutch Shoes & Springs</p>  <p>RH1008/RH1009</p>	<p>10171-Clutch Bell (14T) 1pc</p>  <p>RH1008</p>	<p>10172-Clutch Bell (two speed) 1pc</p>  <p>RH1009</p>	<p>10173-Engine mount 2pcs</p>  <p>RH1008/RH1009</p>
<p>10005-Central Transmission Complete 1Set (Single Speed)</p>  <p>RH1008</p>	<p>10174-Central Transmission Bulkheads 2pcs</p>  <p>RH1008/RH1009</p>	<p>10175-Brake Post 1Set</p>  <p>RH1008/RH1009</p>	<p>10176-Brake Set 1set</p>  <p>RH1008/RH1009</p>
<p>10177-Brake Cup 2pcs</p>  <p>RH1008/RH1009</p>	<p>10178-Single Speed Shaft w/pin</p>  <p>RH1008</p>	<p>10179-50T Gear (Single Speed) 1pc</p>  <p>RH1008</p>	<p>10006-Central Transmission Complete 1Set (Two Speed)</p>  <p>RH1009</p>
<p>10180-Two Speed Clutch 1Set</p>  <p>RH1009</p>	<p>10181-Two Speed Shaft 1pc</p>  <p>RH1009</p>	<p>10182-50T Two Speed Gear 1pc</p>  <p>RH1009</p>	<p>10183-45T Two Speed Gear 1pc</p>  <p>RH1009</p>
<p>10360-N1/N2 Chassis Plate 1pc</p>  <p>RH1008/RH1009</p>	<p>10361-Central Dongbone R. 1pc</p>  <p>RH1008/RH1009</p>	<p>10185-Battery Cover (EP) 1pc</p>  <p>RH1018/RH1019</p>	<p>10188-Battery Post 2sets</p>  <p>RH1018/RH1019</p>

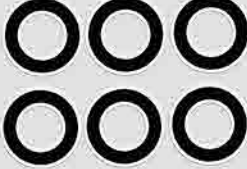

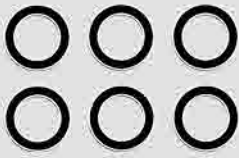





















Part List

<p>10189-Post for Rear Spur Gear Cover 2pc</p>  <p>RH1018/RH1019</p>	<p>10190-Motor Mount (EP) 1pc</p>  <p>RH1018/RH1019</p>	<p>10191-Slipper Complete (EP) 1set</p>  <p>RH1018/RH1019</p>	<p>10192-Slipper Pad (EP) 2pc</p>  <p>RH1018/RH1019</p>
<p>10193-Slipper Gasket (EP) 2pc</p>  <p>RH1018/RH1019</p>	<p>10194-65T Spur Gear (EP) 1pc</p>  <p>RH1018/RH1019</p>	<p>10195P-Slipper Shaft (EP) 1pc</p>  <p>RH1018/RH1019</p>	<p>10196-Slipper Spring Bracket (EP) 1pc</p>  <p>RH1018/RH1019</p>
<p>10197-Slipper Spring (EP) 1pc</p>  <p>RH1018/RH1019</p>	<p>10198-Slipper Coupler (EP) 1pc</p>  <p>RH1018/RH1019</p>	<p>10199-Slipper Drive Cup 1pc</p>  <p>RH1018/RH1019</p>	<p>10200-BEARING BRACKET (EP) 1pc</p>  <p>RH1018/RH1019</p>
<p>10201-Pinion Gear 17T (EP) 1pc</p>  <p>RH1018/RH1019</p>	<p>10203-Spur gear cover (EP) 1pc</p>  <p>RH1018/RH1019</p>	<p>10210-Sway Bar 2Sets</p>  <p>RH1018/RH1019</p>	<p>10364-Body guard frame 2pcs</p>  <p>RH1018/RH1019</p>
<p>10365-Body guard frame bracket 4pc</p>  <p>RH1018/RH1019</p>	<p>10380-Center Drive Shaft (EP) 1pc</p>  <p>RH1018/RH1019</p>	<p>10381-EBD/EBL chassis plate 1pc</p>  <p>RH1018/RH1019</p>	<p>10382-EBD/EBL upper plate 1pc</p>  <p>RH1018/RH1019</p>
<p>85034-Body Clip (Medium Size) 6pcs</p> 	<p>85029-Body Clip (Small Size) 6pcs</p> 	<p>10214-Shock Ball End 6pcs</p> 	<p>10215-Servo Link Ball End 6pcs</p> 

Part List

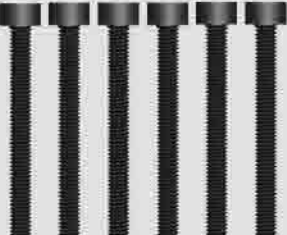



<p>10216-Steering Linkage Ball End 6pcs</p> 	<p>10217-Rear Upper Linkage Ball End 6pcs</p> 	<p>10218-Sway Bar Fix Plate 6pcs</p> 	<p>10219-Sway Bar Holders 6pcs</p> 
<p>10220-Ball A 6pcs</p> 	<p>10221-Ball B 6pcs</p> 	<p>10222-Ball C 6pcs</p> 	<p>10223-Ball D 6pcs</p> 
<p>10224-Shock O-ring (Lower) 6pcs</p> 	<p>10225-Diff O-ring Seal 6pcs</p> 	<p>10226-Shock O-ring (upper) 6pcs</p> 	<p>10227-Tuned Pipe Seal & Fuel Tank Seal 1set</p> 
<p>10228-Pin ϕ2*10 6pcs</p> 	<p>10229-Pin ϕ2*11 6pcs</p> 	<p>10230-Hinge Pins (long & short) 2sets</p> 	<p>10231-One Way Bearing 3pcs</p> 
<p>10232-Ball Bearing 15*10*4 6pcs</p> 	<p>10233-Ball Bearing 10*5*4 6pcs</p> 	<p>10234-Metal Bushing 10*5*4 6pcs</p> 	<p>10235-Ball Bearing 8*5*2.5 6pcs</p> 
<p>10236-E clip-8mm 4pc</p> 	<p>RH5190-E clip-4mm 6pc</p> 	<p>10237-E clip-2.5mm 6pc</p> 	<p>RH5102-Nylon Lock Nut M3 6pc</p> 

Part List

<p>RH5103-Nylon Lock Nut-M4 6pc</p> 	<p>85148-Round Head Self Tapping Hex Screw 2*6 4pcs</p> 	<p>10238-Round Head Self Tapping Hex Screw 2*10 6pc</p> 	<p>85179-Round Head Self Tapping Hex Screw 3*15 8pc</p> 
<p>10239-Round Head Self Tapping Hex Screw M3*6 6pc</p> 	<p>10240-Button Head Hex Screw M3*8 6pc</p> 	<p>10241-Button Head Hex Screw M3*10 6pc</p> 	<p>85184-Button Head Hex Screw M3*12 6pc</p> 
<p>10242-Button Head Hex Screw M3*14 6pc</p> 	<p>85144-Ring Self Tapping Screw 3*4 4pc 10256-Ring Self Tapping Screw 3*6 6pc</p> 	<p>RH5116-Set Screw M3*3 6pc</p> 	<p>RH5117-Set Screw M4*4 6pc</p> 
<p>RH5118-Button Head Hex Screw M4*10 6pc</p> 	<p>RH5562-Cap Head Hex Screw M3*8 6pc</p> 	<p>10243-Cap Head Hex Screw M3*10 6pc</p> 	<p>85182-Cap Head Hex Screw M3*10 6pc</p> 
<p>10244-Cap Head Hex Screw M3*14 6pc</p> 	<p>85119-Cap Head Hex Screw M3*16 6pc</p> 	<p>10245-Cap Head Hex Screw M3*18 6pc</p> 	<p>85185-Cap Head Hex Screw M3*25 6pc</p> 
<p>10246-Cap Head Hex Screw M3*28 6pc</p> 	<p>10247-Flat Head Hex M3*8 6pc</p> 	<p>85125-Flat Head Hex Screw M3*10 8pc</p> 	<p>85175-Flat Head Hex Screw 3*10 8pc</p> 

Part List

<p>10248-Flat Head Hex Screw M3*12 6p</p> 	<p>10249-Flat Head Hex Screw M3*14 6p</p> 	<p>85127-Flat Head Hex Screw M3*18 3p</p> 	<p>10250-Flat Head Hex Screw M3*20 6p</p> 
<p>10251-Flat Head Hex Screw M3*36 6p</p> 	<p>85173-Flat Head Hex Screw M4*10 6p</p> 	<p>H0068 2.4G FS-GT2 TX&RX</p> 	<p>H0014 - 2.4GHz Transmitter 1pc</p> 
<p>H0072 ks 45A ESC 1pc</p> 	<p>H0050-400A ESC 1pc</p> 	<p>H0028 - 3650 Brushless Motor 1pc</p> 	<p>H0029 - 550 Brushed Motor 1pc</p> 
<p>H0030 - Ni-MH 7.2V 1800mAh 1pc H0031 - Ni-MH 7.2V 3000mAh 1pc</p> 	<p>H0012 - Battery Case 1pc</p> 	<p>H0011 - 3kg/cm Servo 1pc</p> 	<p>85274-Li-Po 2700mAh 7.4V 1pc</p> 
<p>10253 - 1/10 Charger CE 1pc 10254 - 1/10 Charger UL 1pc 10255 - 1/10 Charger BS 1pc</p> 	<p>RH5189 - Receiver Switch 1pc</p> 	<p>85284-Battery case 1pc</p> 	<p>85285-RX case 1set</p> 
<p>R0092-Printed SC trusk body 1pc</p> 	<p>R0079-Printed SC trusk body 1pc</p> 	<p>10258-waterproof cover 1pc</p> 	<p>10607 Rear suspension arm pins w/screws 2pcs</p> 

<p>10608 Rear bumper Fix plate(alloy) w/ screws 2pcs</p> 	<p>10609 Flat hex screw M3*40 6pcs</p> 	<p>10610 Rear bumper fix plate & suspension arm pins set</p> 	<p>10969 Alloy front suspension holders 1set(Optional)</p> 
<p>10970 Alloy rear suspension holders 1set(Optional)</p> 			

Upgrade Parts List

<p>10902 - Front Shock Plate (Carbon) 1Set</p>  <p>RH1008/RH1009/RH1018/RH1019</p>	<p>10903 - Rear Shock Plate (Carbon) 1Set</p>  <p>RH1008/RH1009/RH1018/RH1019</p>	<p>10906-Body Post (AL) 2pc</p>  <p>RH1018/RH1019</p>	<p>10907-Front Shocks (AL) 2pc</p>  <p>RH1008/RH1009/RH1018/RH1019</p>
<p>10908-Rear Shocks (AL) 2pc</p>  <p>RH1008/RH1009/RH1018/RH1019</p>	<p>10909 - Front Lower Susp. Arm (AL) 2pc</p>  <p>RH1008/RH1009/RH1018/RH1019</p>	<p>10910 -Rear Lower Susp. Arm (AL) 2pc</p>  <p>RH1008/RH1009/RH1018/RH1019</p>	<p>10911 - Steering Ackerman (AL) 1pc</p>  <p>RH1008/RH1009/RH1018/RH1019</p>
<p>10912 - Front Susp. Holders (AL) 1Set</p>  <p>RH1008/RH1009/RH1018/RH1019</p>	<p>10913 - Front & Rear Brace(AL) (AL) 1Set</p>  <p>RH1008/RH1009</p>	<p>10914 - Rear Susp. Holders (AL) 1Set</p>  <p>RH1008/RH1009/RH1018/RH1019</p>	<p>10915 - Rear Hub Carrier (AL) 2pc</p>  <p>RH1008/RH1009/RH1018/RH1019</p>
<p>10916-Front Top Plate (Carbon) 1pc</p>  <p>RH1008/RH1009</p>	<p>10917 - Steering Knuckle Arm (AL) 2Set</p>  <p>RH1008/RH1009/RH1018/RH1019</p>	<p>10918 - Wheel Hub (AL) 4pc</p>  <p>RH1008/RH1009/RH1018/RH1019</p>	<p>10919 - Upper Plate(AL) 1pc</p>  <p>RH1008/RH1009</p>
<p>10920 - Tuned Pipe(AL) 1Set</p>  <p>RH1008/RH1009</p>	<p>10921 - Chassis Brace mount (AL) 1pc</p>  <p>RH1008/RH1009</p>	<p>35265 - Heatsink 1pc</p>  <p>RH1018/RH1019</p>	<p>10923 - Alum Steering Arm 2pc</p>  <p>RH1008/RH1009/RH1018/RH1019</p>
<p>10924 - Alum Knuckle Arm 2pc</p>  <p>RH1008/RH1009/RH1018/RH1019</p>			

1/10 Scale 4WD RC Nitro Powered Car

RH1008 DT5 N1 (Single Speed)

RH1001 Specs.:

1. Length: 530 mm (N1)
2. Width: 290 mm (N1)
3. Height: 180 mm (N1)
4. Wheelbase: 325 mm
5. Gear Ratio: 8.3:1
6. Tyre: $\phi 95 \times 40$ mm (N1)
7. Weight: 1850 g (N1)

Standard Equipments:

1. Steering Servo: 3kg/cm
2. Throttle Servo: 3kg/cm
3. Engine: G0.18 or SH.18
4. Radio: 2CH AM

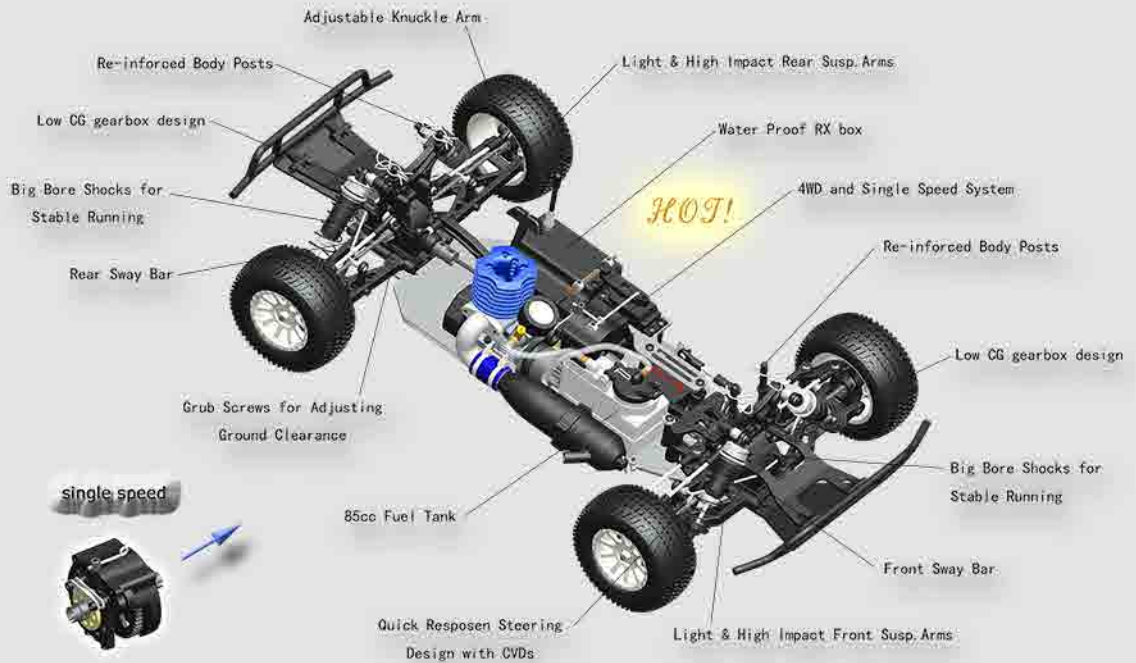

RH1009 DT5 N2 (Two Speed)

RH1002 Specs.:

1. Length: 530 mm (N2)
2. Width: 290 mm (N2)
3. Height: 180 mm (N2)
4. Wheelbase: 325 mm
5. Gear Ratio: 6.1:1 (H)
9.1:1 (L)
6. Tyre: $\phi 95 \times 40$ mm (N2)
7. Weight: 1900 g (N2)

Standard Equipments:

1. Steering Servo: 3kg/cm
2. Throttle Servo: 3kg/cm
3. Engine: G0.18 or SH.18
4. Radio: 2CH AM

